



Compliance of the UK Transmission and Distribution Networks and Generating Equipment with Occupational Exposure Limits

Version Control

Issue	Status	Date	Principal changes
1	Approved by ENA EMF Strategy Committee in advance	Published 30 June 2016	
2.1	Approved by ENA EMF Strategy Committee	Approved 6/12/16, published 7/12/16	New sections on distribution cable tunnels and metering. Typos and formatting corrected.
2.2	Approved by ENA EMF Strategy Committee	Approved 10/5/17, published 10/5/17	New sections on GIS substations and PMR; expanded section on series compensators; text on air cored reactors revised to confirm controls are in place.
2.3	Approved by ENA EMF Strategy Committee	Approved 9/5/18, published 10/5/18	Updated references to EN50647 following publication. Added discussion of harmonics in SVCs. Added photos of single-phase cables.

2.4	Draft	Discussed 20/6/19, subsequent edits June 2019	New section on HVDC cables and edits to section on HVDC convertor stations. New sections on telecommunications antennas and on satellite dishes. Additional information included in Triggers for reassessment
-----	-------	---	---

Table of Contents

1. Introduction.....	5
1.1 How the Risk Assessments are structured.....	5
1.2 The exposure limits.....	5
2. Generic issues	7
2.1 Active medical devices.....	7
2.2 Passive medical devices	7
2.3 Pregnant staff	8
3. The Risk Assessments.....	10
3.1 Activities not requiring further assessment.....	11
3.2 Towers and overhead lines	12
3.3 Live work at 275 and 400 kV.....	19
3.4 Live-line work: Annex.....	21
3.5 Live work at 11 kV.....	24
3.6 Live work at 11 kV: modelling annex.....	27
3.7 Approach to a single insulated conductor.....	30
3.8 Substations 275 and 400 kV and above, HV compounds, not including SVCs	33
3.9 Substations 275 and 400 kV and above, Gas Insulated Switchgear (GIS)	36
3.10 Substations 275 and 400 kV and above, areas outside HV compounds.....	37
3.11 Substations 33 kV-132 kV, not including SVCs	40
3.12 Air-Cored Reactors	42
3.13 Air-cored reactors Annex: assessment of specific designs.....	44
3.14 Series Compensators	50
3.15 Substations 11 kV.....	53
3.16 Transmission Cable tunnels.....	55
3.17 Distribution cable tunnels	58
3.18 Live jointing.....	60
3.19 Metering and associated activities	61
3.20 Fault switching	64
3.21 Mobile generators	66
3.22 Welding activities	68
3.23 Telecommunications equipment.....	72
3.24 Fault currents and transients.....	77

3.25	HVDC convertor stations.....	81
3.26	HVDC cables	83
3.27	Operation of Generators – Routine Generation.....	85
3.28	Operation of Generators – Infrequent Activities.....	88
3.29	Power Distribution.....	90
3.30	Ancillary Equipment	93

1. Introduction

This document fulfils, for member companies of the Energy Networks Association and Energy UK, the requirement of the Control of Non-Ionising Radiation Regulations 2016 for employers to be in possession of an Exposure Assessment, a Risk Assessment, and an Action Plan. It should be read in conjunction with the ENA, Energy UK, or company-specific Policy.

1.1 How the Risk Assessments are structured

The Assessments are structured by plant item or by work practice, rather than by site or by individual worker.

For each plant item/work practice, the approach is to identify the worst case (the specific instance or the combination of circumstances that produces the highest exposure) and to assess compliance for this.

For each plant item or work practice, there are six standard sections:

- a brief description of the activity;
- a summary of the exposures produced;
- an assessment of those exposures against the various exposure limits in the Directive;
- a conclusion on compliance, either that no action is needed, or a recommended action to achieve compliance;
- an explicit statement of what changes, if any, would require this conclusion to be revisited; and
- a record as to provenance of the assessment.

1.2 The exposure limits

ENA policy is normally to comply with the High Action Levels of the Regulations:

- For magnetic fields: 6 mT (exposure to limbs only 18 mT)
- For electric fields: 20 kV/m

Many activities in fact comply with the Low Action Levels:

- For magnetic fields: 1 mT
- For electric fields: 10 kV/m

This Risk Assessment assesses first against the Low Action Levels. If these are exceeded, it assesses against the High Action Levels. Assessment is also made against the public exposure reference levels, of relevance to staff at particular risk.

The Policy allows for the alternative of compliance with the Exposure Limit Values in specific circumstances, which are detailed in this Risk Assessment as appropriate. The field required to induce the Exposure Limit Value is known as the Limit Equivalent Field. The value can be calculated for specific circumstances but for uniform fields it can be taken as 7 mT for magnetic fields and 35 kV/m for electric fields, following the CENELEC Standard EN- 50647:2017¹.

¹ BS EN 50647:2017. Basic standard for the evaluation of workers' exposure to electric and magnetic fields from equipment and installations for the production, transmission and distribution of electricity.

2. Generic issues

2.1 Active medical devices

Active Implanted Medical Devices and Body-Worn Medical Devices are assumed to be immune to interference at field levels below the general-public reference levels, 100 μ T and 5 kV/m. For fields above these levels, it should be assumed that interference is possible (though the immunity of individual devices is usually considerably higher and can be assessed on a case-by-case basis). The procedures set out in the Policy should then be applied.

Justification:

Active Implanted Medical Devices are governed by general requirements from the Active Implantable Medical Devices Directive² and the Medical Devices Regulations 2002. Then there are a number of Standards spelling out the detailed requirements for specific devices, including specifically requirements on immunity from interference from EMFs.³ The result of these is that, for the specific devices covered (so far, principally pacemakers and defibrillators), immunity from interference can normally be assumed at the general public reference levels, 100 μ T and 5 kV/m. It is assumed that similar provisions apply in practice to all active devices, and that standards will eventually codify this for other devices.

For some time, those manufacturers of cardiac devices who have specified levels of immunity for power-frequency fields have usually specified 100 μ T and 6 kV/m. Recently, at least one manufacturer has started quoting 10 kV/m instead of 6 kV/m. This confirms that it is appropriate to assume immunity up to the general public reference levels.

2.2 Passive medical devices

Passive medical devices include rods, pins, nails, screws, plates, and implanted joints. There are no significant risks to a person with a passive device from power-frequency fields.

Justification:

² 90/385/EEC first established in 1990 with subsequent amendments

³ BS EN 45502-1: 1998. Active implantable medical devices Part 1. General requirements for safety, marking and information to be provided by the manufacturer.

BS EN 45502-2-1: 2003. Active implantable medical devices Part 2-1. Particular requirements for active implantable medical devices intended to treat bradyarrhythmia (cardiac pacemakers).

BS EN 45502-2-2: 2008. Active implantable medical devices Part 2-2. Particular requirements for active implantable medical devices intended to treat tachyarrhythmia (includes implantable defibrillators).

BS EN 50527-1:2010. Procedure for the assessment of the exposure to electromagnetic fields of workers bearing active implantable medical devices. General.

BS EN 50527-2-1:2011. Procedure for the assessment of the exposure to electromagnetic fields of workers bearing active implantable medical devices - Part 2-1: Specific assessment for workers with cardiac pacemakers.

Being passive devices, these do not experience interference or any impairment of function themselves.

Heating is a recognised risk at radiofrequencies but is not expected to be significant at power frequencies.

Passive devices will enhance any induced electric field in the body at their ends, and this could in principle lead to the ELV being exceeded in a local region when the fields in the rest of the body are compliant.

There are no known reports of any health or safety issues arising in practice from passive devices and power-frequency fields.

At least one calculation of this effect has been published⁴, considering, as a deliberately chosen worst case, an intramedullary femoral nail with the field aligned to the long axis. This study found an enhanced induced electric field at the ends of the nail, principally confined to a volume comparable in dimensions to the diameter of the nail. Given the limited volume, the low probability of the passive implant being at the location in the body and aligned in the direction where compliance with the limits is critical, and the safety margins in the exposure limits, it is judged that any risk is unlikely to be significant. Given the ubiquity of passive devices, any general control measures are judged to be disproportionate. However, the option to investigate particular situations on a case-by-case basis should be retained.

2.3 Pregnant staff

Staff who notify their employer that they are pregnant are given the option of complying with the public exposure limits for the duration of their pregnancy. In this case, the limits in question are the fields corresponding to the public basic restriction, 360 μ T and 9 kV/m, not the reference levels that apply for active medical devices.

Justification:

Pregnant women are one of the groups of “workers at particular risk” defined in the Regulations (and also in the ICNIRP 2010 exposure limits⁵ from which the Regulations, via the Directive, draw their scientific underpinning).

Employers are required to take specific account of these workers in their Risk Assessment (Regulation 8(2)(j)). However, the Regulations do not specify what the outcome of this risk assessment should be. Neither the Directive nor the ICNIRP 2010 limits give specific requirements, although the 2011 draft version of the Directive stated:

⁴ Current Density in a Model of a Human Body With a Conductive Implant Exposed to ELF Electric and Magnetic Fields. Blaz. Valic, Peter Gajsek and Damijan Miklavcic. Bioelectromagnetics 2009.

⁵ Guidelines for Limiting Exposure to Time-Varying Electric and Magnetic Fields (1 Hz - 100 kHz). ICNIRP. Health Physics 99(6):818-836; 2010.

“The employer shall enable the worker to avoid having to enter areas where exposures exceeding the exposure limits for the general public given in Council Recommendation 1999/519/EC, or its subsequent revisions.”

This provision was removed from the final version.

The HSE Guidance to the Regulations states:

“Expectant mothers

As working with certain levels of EMFs could result in a greater risk to an expectant mother, you should encourage your workers to advise you in writing if they become pregnant. You may wish to take a practical approach and limit the exposure of expectant mothers to the public exposure limits. These are stated in Council Recommendation 1999/519/EC, see Useful links ref2

If risks from EMFs are identified during pregnancy, you must take appropriate action to eliminate, reduce or control the risks; they must be included and managed as part of the general workplace risk assessment.”

For radiofrequencies, where the effect being protected against is heating, there is clear evidence that the embryo or unborn baby and the expectant mother can be more susceptible to heating effects than the general population, and a lower limit is appropriate. For power frequencies, the evidence is less clear. There are suggestions, e.g. in the then National Radiological Protection Board’s 2004 review of the science and recommendations⁶, that the developing central nervous system could be susceptible, concluding:

“These data indicate that a degree of caution is appropriate when considering the potential susceptibility of the developing nervous system, both in utero and in neonates and young children to weak induced time-varying electric fields.”

It is concluded that as a matter of precaution and reassurance, it is entirely appropriate to allow the pregnant woman and unborn baby to be restricted to the general public limits. However, it is also concluded that as there is no requirement for this in any of the relevant exposure limits and no clear evidence of any actual risk up to the normal occupational limits, and also given that exposures will occur before the woman knows she is pregnant or chooses to notify her employer, this should not be a requirement but should be offered to the woman concerned as an option.

⁶ “Advice on Limiting Exposure to Electromagnetic Fields (0-300 GHz)” Documents of the NRPB Volume 15 No 2 2004. “Review of the Scientific Evidence for Limiting Exposure to Electromagnetic Fields (0-300 GHz)” Documents of the NRPB Volume 15 No 3 2004

3. The Risk Assessments

3.1 Activities not requiring further assessment

3.1.1 Description of activity

Activities and workplaces listed in Table 3.2 (column 1) of the EU Non-binding Guide⁷ or the broadly equivalent Table 2 of the HSE Guide⁸ are deemed not to require further assessment, in many cases because they already comply with the public exposure limits.

The activities relevant to this industry are:

- All office locations, including wifi and Bluetooth equipment, computing equipment, etc
- Use of mobile phones and two-way radios
- Alarm systems
- Broadcast or cellular antennas, outside the exclusion zone
- Metal detectors
- Tape or hard-drive erasers (office, not industrial)
- Battery chargers, wired or inductive
- Machine tools
- Construction equipment (cranes, MEWPs, cement mixers etc)

3.1.2 Summary of exposures

Exposures are, by definition, compliant.

3.1.3 Assessment of exposures

No further assessment needed.

3.1.4 Control measures

No control measures needed.

3.1.5 Triggers for reassessment

Any changes to Table 2 in HSG281.

3.1.6 Assessment performed by

John Swanson, National Grid, 22/6/16. Based on information publicly available.

⁷ "Non-binding guide to good practice for implementing Directive 2013/35/EU Electromagnetic Fields"

⁸ "A guide to the Control of Electromagnetic Fields at Work Regulations 2016" (HSG281)

3.2 Towers and overhead lines

3.2.1 Description of activity

Staff climb the bodies of towers with live circuits at 400 and 275 kV. The highest exposures are experienced when abreast of one of the conductor bundles.

3.2.2 Summary of exposures

The maximum exposure is at the point of closest approach to one of the conductor bundles, that is, abreast of the bundle while climbing past it. The distance of approach is reduced from that produced by the normal tower geometry if the conductor bundle is blown towards the tower body by the wind. The closest approach is limited by the permissible high-voltage safety clearance distance.

For magnetic fields, it is acceptably accurate to assess the field solely from the closest conductor bundle. For a minimum approach distance of 3 m, the current in the bundle required to produce the Low Action level, 1 mT, is 15 kA.

For electric fields, two sets of measurements have been performed on an L2 400 kV tower (broadly speaking, the design of tower with the smallest clearances and therefore expected to give the highest field). The exact values of field are highly dependent on perturbation by steelwork or by the operator and therefore on the exact position of the measurement. These measurements should therefore be taken as indicative of the general magnitudes. The red lines indicate the direction of the parallel plates of the meter used, so the field direction is perpendicular to them.

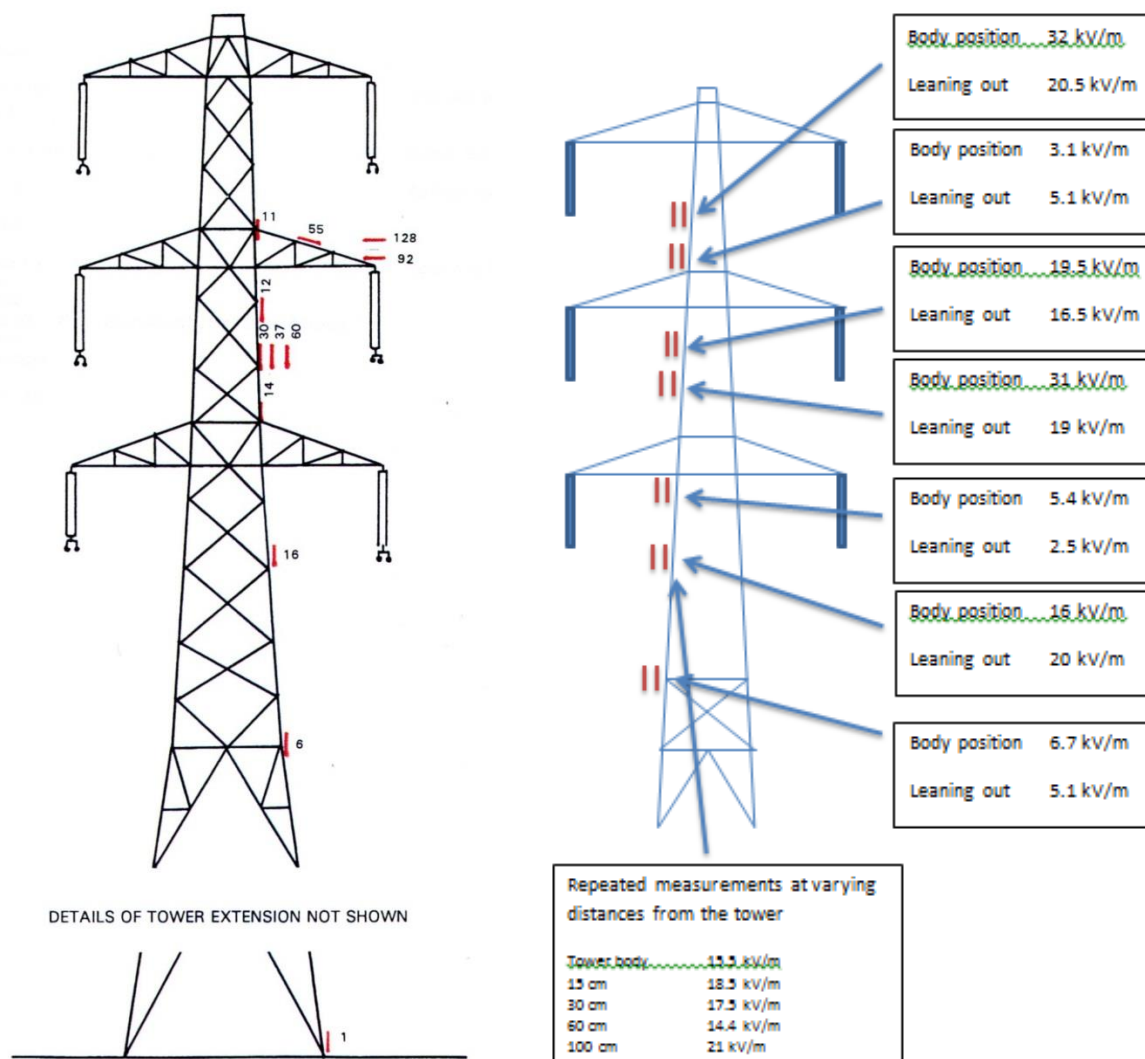

3.2.3 Assessment of exposures

Magnetic fields

For a minimum approach distance of 3 m, the current in the bundle required to produce the Low Action Level, 1 mT, is 15 kA, or for the High Action Level, 6 mT, 90 kA. This is well above any foreseeable rating used in the UK.

Electric fields

The fields measured at the positions close to the tower body that would be occupied by staff are less than 50 kV/m (even allowing for measurement uncertainties, perturbations etc). This exceeds the Higher Action Level and probably the Health Effects ELV as well. However, the Action levels and ELV are calculated on the basis of a field aligned along the length of the body. Fields on tower bodies are transverse, and the coupling to the field for a transverse orientation is less effective, so a smaller induced field will result from the same external field.

Three alternative methods for assessing this are considered here.

1 Simple method based on form factors

As a rough quantification of this, assume that the total short-circuit current induced in a person by an electric field is proportional to the height (measured parallel to the field) squared, but that as they rotate from aligned parallel to aligned transverse to the field, the charge collecting area increases as well. Assume that the total current induced in the different postures is proportional to the “height” (the body dimension measured parallel to the field). Assume a person is typically 1.7 m tall but 0.4 m transversely. The ratio of total short-circuit current induced by a given field applied longitudinally and transversely is then $1.7/0.4 = 4.3$. A different fraction of this total current will flow through the different tissues; this factor cannot readily be quantified so is not included here. Therefore, the same in-situ field as is induced in longitudinal orientation by the High Action Level field of 20 kV/m would be induced by $4.3 \times 20 = 85$ kV/m in transverse orientation. The field experienced by the linemen is less than this orientation-adjusted Action Level with a margin to allow for measurement uncertainties etc.

2 Semi-empirical method based on EPRI material

Based on the published literature, for a human body in perfect contact to the ground and exposed to uniform vertical electric field (the reference exposure situation), the order of magnitude for the contact current is 15 μ A per kV/m. In other words, when exposed to a 10 kV/m vertical electric field, the contact current is about 150 μ A.

An EPRI publication⁹ gives a formula to assess the contact current flowing through a standing human body exposed to an electric field:

$$I = \alpha.l^2.f.E$$

Where l is the length of the body

f is the frequency of the electric field

α is a parameter depending on the orientation of the field with regard to the body.

For the reference exposure situation (human body standing at ground level and exposed to a vertical E field), EPRI gives $\alpha = 9.10^{-11}$ for a 60 Hz field. When applied to a human body 1.75 m tall and exposed to a 50 Hz 10 kV/m field, the formula gives $I = 140$ μ A, fairly consistent with the 150 μ A previously given.

The EPRI study has also investigated the exposure situation of a worker climbing a tower, using a standing conducting mannequin supported by a harness and connected to the tower by the feet, as illustrated:

⁹ Field effects of overhead transmission lines and stations (from: Transmission Line Reference Book : 345 kV and above), EPRI, 1982 – DW. Deno et L. Zaffanella

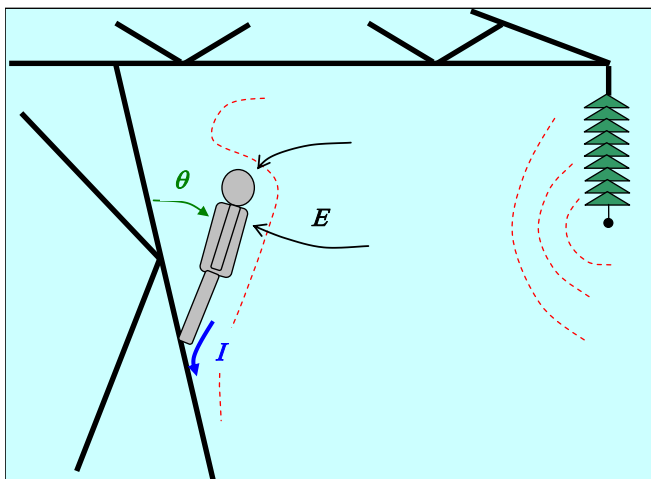

For an angle $\theta = 30^\circ$, the EPRI study gives $\alpha = 5.7 \times 10^{-11}$. When applying the above formula to a man 1.75 m tall, and exposed to a 10 kV/m E-field, it results in an induced current $I = 87 \mu\text{A}$, therefore 38 % lower than the value calculated in the reference exposure situation. In other words, a worker climbing a tower and exposed to a 10 kV/m E-field (averaged exposure) has an actual exposure equivalent to a man standing at ground level in a 6.2 kV/m vertical field. In this situation, a 30 kV/m averaged exposure in a tower would be equivalent to 18.6 kV/m at ground level, therefore lower than the high AL.

Expressed alternatively, the High AL of 20 kV/m for the reference exposure situation is equivalent to an average exposure on the tower in this situation of 31.9 kV/m. If the field required to induce the Exposure Limit Value (known as the Limit Equivalent Field) is taken as 35 kV/m for the reference situation (following the draft CENELEC Standard prEN- 50467), this is equivalent to 55.9 kV/m.

This approach of using the contact current to scale the electric field to different coupling scenarios is only approximate, because the contact current is only an approximation to the quantity of ultimate interest, the induced electric field in the relevant organs. The distribution of a given contact current through the body will, in principle, change with the orientation of the external field. However, EPRI record that the fraction of the total contact current induced in the head is 0.29 for the 30-degree-from-tower situation compared to 0.30 for the vertical situation, suggesting the difference may not be large in practice. The values of α are for the feet well grounded, and would be lower for practical situations where the feet are not perfectly grounded, but this is expected to have a similar effect on both exposure situations and therefore not to alter the ratio between the two situations.

Although experimental data are available only for the one angle of lean out from the tower, 30 degrees, the contact current is expected to depend strongly on this angle. At 30 degrees out from the tower, the person has attained roughly 50% ($\sin\theta$) of the distance from the ground plane of the reference situation, and therefore roughly (for a uniform field) 50% of the space potential, but is still presenting 87% ($\cos\theta$) of the perpendicular area to the field as when they are flat against the tower. It is expected that the ratio of $\alpha_{\text{reference}}/\alpha_{\text{angled}}$ will increase as the angle reduces below 30 degrees.

For the ELVs related to health, the limiting region of the body is likely to be the ankles, where the greatest current is channelled through the smallest area. Making contact with the tower with a hand would reduce the current through the ankle, but the worst case scenario remains the worker grounded through the feet but not the arms or hands.

3 method based on unpublished dosimetry

As stated above, there are no published dosimetric calculations dealing with fields oriented other than vertically along the body. However, one set of unpublished data are available (Findlay 2015 personal communication). These modelled a person standing against a vertical ground plane in a uniform horizontal electric field, with the person either vertical or leaning out 30 degrees (these diagrams show cuboidal representations of the person but the calculations were performed for anatomically realistic shapes with 2 mm resolution):

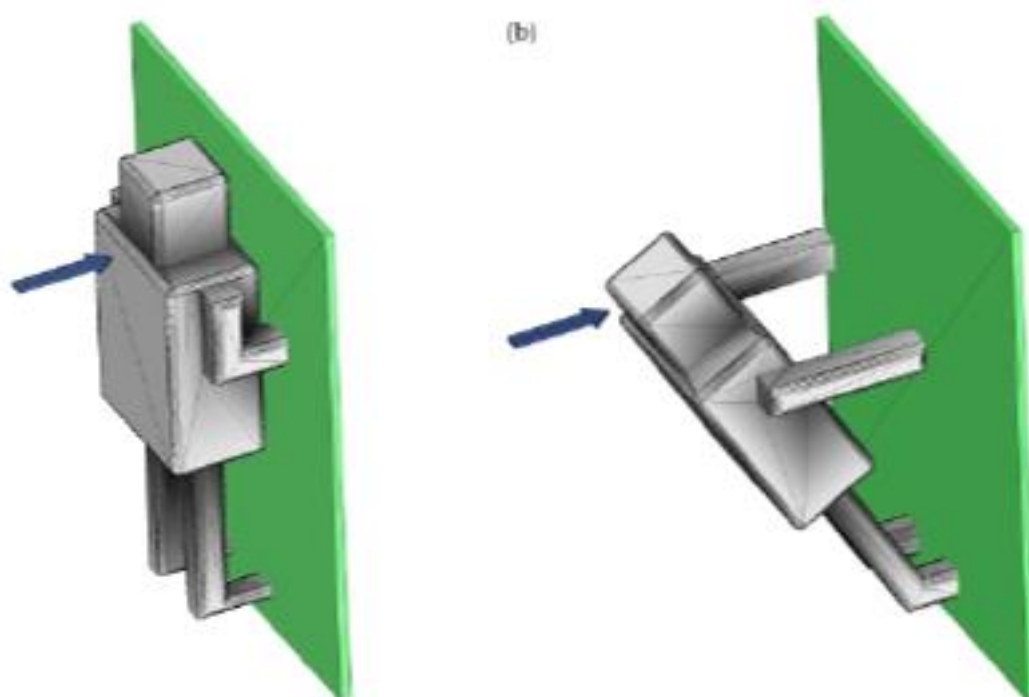

They were each modelled either grounded through the feet only, or through the feet and hands. The results for the worst case organ in either the CNS or the whole body are given in the table:

	tissue	coupling geometry		
		vertical	leaning out 30 degrees	reference exposure situation for comparison
		horizontal field		vertical field
grounded through feet only	CNS	2.03	1.99	1.65
	whole body	19.1	23.5	33.1
grounded through feet and hands	CNS	1.93	1.59	not relevant
	whole body	7.37	6.13	

All values in mV/m / kV/m and are 99%ile for the worst-case tissue type.

For the whole body, these results behave as expected. Results for “vertical” are less than for “leaning out” and both are less than for “reference”. Grounding the hands as well as feet significantly reduces the values. The ratio of “leaning out by 30 degrees” to “reference” for feet-only grounding is 0.71 compared to the EPRI value of 0.62, which is probably reasonable agreement given the approximations. On this basis, for “vertical”, the ratio would be 0.58.

However, the values for CNS do not similarly behave in the way expected and suggest that this exposure scenario is in fact more onerous than the reference, which does not make sense. This casts doubt on the overall reliability of this work.

Although all three of these methods have approximations and weaknesses, the overall conclusion is that the exposures expected on towers are compliant with the ELV, and possibly also with the High AL, when orientation is taken into account.

3.2.4 Control measures

None needed as the fields are compliant.

This work involves the risk of microshocks, which are controlled through provision of appropriate footwear, gloves, harnesses, and provision of advice, including the facility to report towers giving particular concern.

This work triggers the procedures for identifying staff with AIMDs and pregnant staff.

3.2.5 Triggers for reassessment

Use of conductor bundles with ratings of 10 kA or more.

Use of alternative tower designs where it is possible for a person on the tower structure to be aligned with the electric field.

3.2.6 Assessment performed by

John Swanson, National Grid, 22/6/16. Based on stated sources of information. Typos corrected 23/11/16.

3.3 Live work at 275 and 400 kV

3.3.1 Description of activity

Staff work on conductor bundles at 275 and 400 kV while they are live.

Work is usually from a trolley, placed onto the conductors by a helicopter, though alternatives such as access from the tower using insulated rods have been used in the past.

3.3.2 Summary of exposures

Electric field exposures to the staff are eliminated by wearing a conducting suit (including gloves and hood).

Magnetic fields can be many tens of milliteslas on the surface of the conductors, certainly exceeding the High Action Level, but are highly non-uniform, and therefore dosimetric calculations are needed to assess compliance.

3.3.3 Assessment of exposures

National Grid commissioned a specialist group in Canada to perform such calculations in 2002, specific to the geometries relevant to UK live-line work, and the results were published in the scientific literature¹⁰. A detailed National Grid internal report analysed this published work and extracted the values necessary to assess compliance. Relevant extracts are included in the Annex to this section. The chosen control measure to ensure compliance is to limit the current flowing in the conductors. For compliance with ICNIRP 1998, as applied in National Grid prior to the Regulations, this resulted in limits on the current which were less than the ratings, and therefore needed a system for controlling the currents during live-line operations. For the Regulations, however, the limits are larger than the ratings of the conductors currently in use, and no system of controls is needed.

3.3.4 Control measures

Electric field

Live-line suits, as worn for other reasons, ensure compliance.

Magnetic field

No controls needed.

This work triggers the procedures for identifying staff with AIMDs and pregnant staff.

¹⁰ T. W. Dawson, K. Caputa, and M. A. Stuchly, "Magnetic field exposures for UK live-line workers," *Phys. Med. Biol.*, vol. 47, no. 7, pp. 995-1012, Apr.2002

3.3.5 Triggers for reassessment

Use of live-line techniques on conductors with ratings greater than 2.4 kA per subconductor.

3.3.6 Assessment performed by

John Swanson, National Grid, 22/6/16. Based on referenced published paper.

3.4 Live-line work: Annex

This Annex contains the relevant extracts from National Grid Technical Report TR(E)173 issue 2 2011, which analyses the dosimetric calculations of Dawson, Caputa and Stuchly 2002¹¹.

TR(E)173 analyses both the induced-current dosimetry relevant to ICNIRP 1998 and the induced-field dosimetry relevant to ICNIRP 2010 and the Directive. The extracts presented here are just those relevant to the Directive, but the original table numbering has been preserved even though it is now non-sequential.

Results of the dosimetry are given in table 2. The choices that are made in extracting these values are:

Summary metric: the paper presents, for each tissue type, maximum, average, and L99. We use L99 because that is specified by ICNIRP.

Averaging: no averaging is necessary because the 3.6 mm voxel used in the calculations is already slightly larger than the 2 mm specified by ICNIRP (we assume not so much larger as to invalidate the results).

Tissue types: There are two limits to consider, in the “CNS tissue of the head” and in the whole head and body.

Considering the “CNS tissue of the head”: this comprises the brain and the retina, and the brain always has a higher induced field than the retina, for all postures and bundles. The spinal cord is higher still, but this is excluded in ICNIRP 2010, which specifies head only. Therefore we use the values for the brain.

Considering the whole head and body: this limit stems from a consideration of peripheral nerve stimulation. Therefore, logically, it should not be taken as the worst case over all the tissues of the whole head and body, but only over tissues, anywhere in the head and body, containing nerves. This approach is endorsed in the ICNIRP text (p825 column 2).

ICNIRP themselves suggest using the skin (p824 column 1):

“There is no conversion factor for peripheral nerve tissue available at present. Therefore, the skin, which contains peripheral nerve endings, was chosen as a worst-case target tissue.”

However, the Dawson paper does not present results for the skin separately, though it is one of the tissues modelled, as listed in table A1 of that paper. We therefore take, for each posture, the worst case tissue of those that are presented (the most comprehensive

¹¹ T. W. Dawson, K. Caputa, and M. A. Stuchly, "Magnetic field exposures for UK live-line workers," *Phys. Med. Biol.*, vol. 47, no. 7, pp. 995-1012, Apr.2002

presentation is in the appendix and comprises blood, bone, heart, kidneys, liver, marrow, muscle, pineal and prostate). In each case, this is the marrow.

			head		Any tissue (marrow)	
			mV/m / kA	kA / subconduct or	mV/m / kA	kA / subconduct or
bundle and posture	Twin	Across, chest	17	5.9	116	6.9
		Across, head	41	2.4	69	11.5
		Along, Head	20	5.0	40	20.0
	Triple	Across, chest	23	4.3	128	6.3
		Across, head	29	3.4	102	7.8
		Along, Head	26	3.8	58	13.7
	Quad	Across, chest	33	3.0	255	3.1
		Across, head	56	1.8	199	4.0
		Along, Head	35	2.9	93	8.6
		Away, chest	47	2.1	151	5.3

Table 2 - Results of Dawson et al dosimetry for induced field relevant to ICNIRP 2010

We note that in every posture, the operative limit comes from consideration of the head rather than the whole body. However, the skin would only have to be a few percent more sensitive than the marrow to become the limiting case for at least some postures. So we cannot ignore the “whole body” limit altogether. Nonetheless, the skin would have to be 3 or 4 times more sensitive than the marrow for the limit on subconductor current derived from it to get below the subconductor rating.

....

We assume here that the limit is applied entirely through a limit on current, with no account taken of separation. The limit could be expressed per subconductor or per bundle, and could be different for each bundle type, or, for simplicity, taken as the value for the limiting bundle applied to all bundles. The following tables give values for these alternatives.

ICNIRP 2010

kA	per subconductor			per bundle		
	twin	triple	quad	twin	triple	quad
proposed value	2.4	2.4	1.8	4.8	7.2	7.2

(assuming skin is not greatly more sensitive than marrow)						
---	--	--	--	--	--	--

Table 5 - Limits necessary to achieve compliance with ICNIRP 2010

.....

Comparison with ratings

Winter pre-fault ratings for the different bundles are taken from TGN E(26) 2001 (using Redwood 90 °C for twin, Araucaria 90 °C for triple, and Zebra 75 °C for quad). These are not intended as definitive statements of the rating, but simply to give an indication of how much of a restriction the proposed limits would be.

kA	per subconductor			per bundle		
	twin	triple	quad	twin	triple	quad
winter pre-fault rating	1.9	1.7	1.0	3.8	5.1	4.2

Table 6 - Ratings of conductors and bundles

3.5 Live work at 11 kV

3.5.1 Description of activity

Work is performed on conductors of 11 kV lines whilst live, usually by staff standing in buckets on insulated MEWPs. The conductors not being worked on are covered in insulating shrouds, but the conductors being worked on are partially bare.

3.5.2 Summary of exposures

Exposures have been measured by portable loggers attached to a linesman's harness while undertaking live work on an 11 kV circuit which was carrying 60 A at the time.

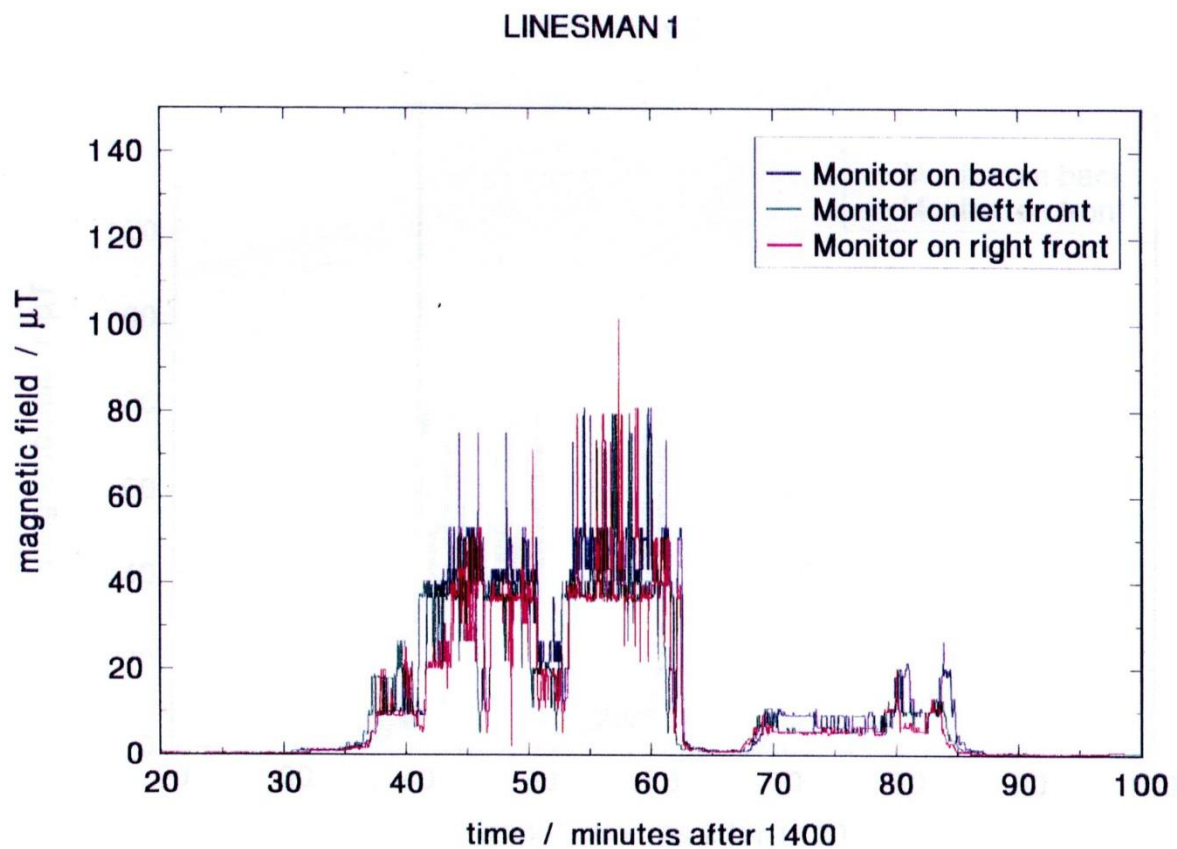

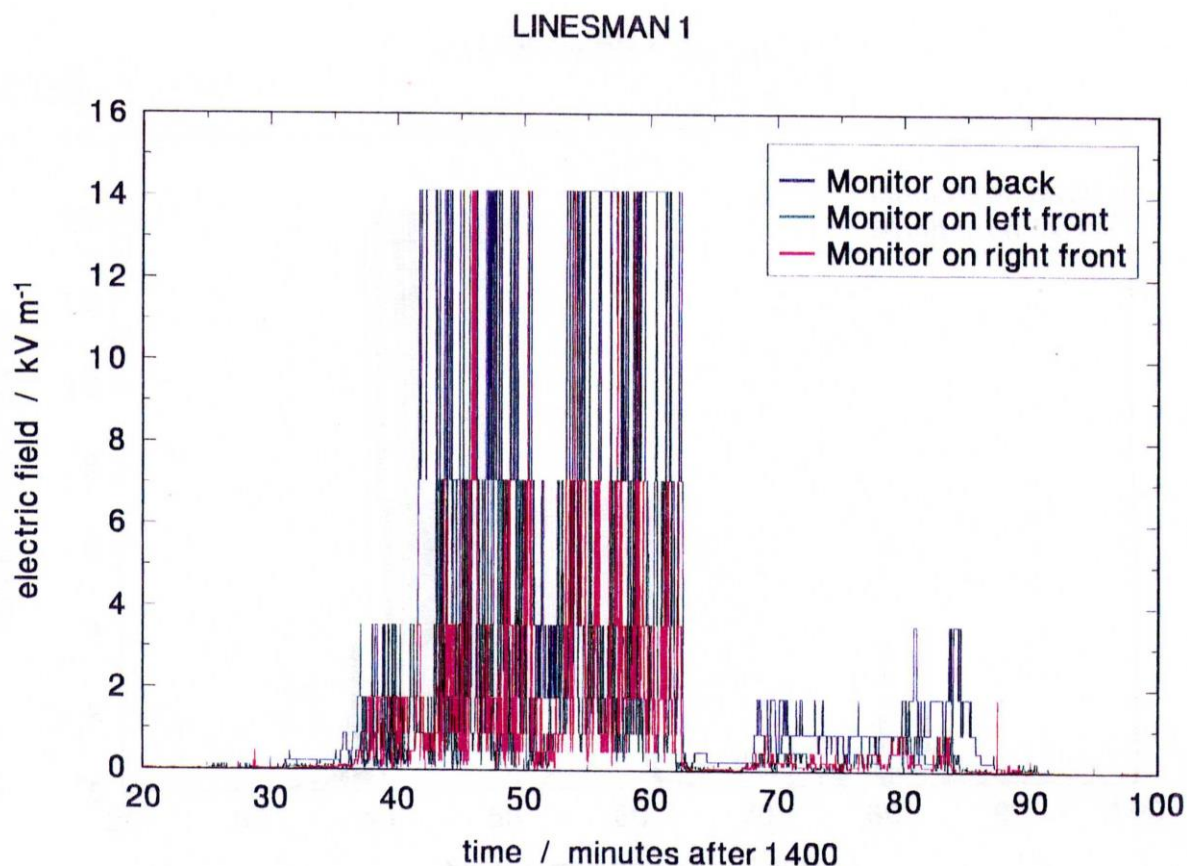

If the maximum magnetic field recorded is taken as 100 μT for a current of 60 A, this scales to 1 mT for a current of 600 A. The maximum electric field recorded was 14 kV/m.

3.5.3 Assessment of exposures

The measured fields suggest that exposures to the general mass of the trunk are below the Lower Action levels. The maximum continuous current during live work on 11 kV lines is taken as 400 A, so the magnetic fields would remain below the Lower Action level even at maximum current. Compliance with the High AL is therefore ensured by a larger margin.

However, these values are dependent on exactly how close each monitor came to the conductors, and, for electric fields, to any screening, so may not represent a true worst case. Accordingly, simplified analytic calculations were performed, presented in the Annex. These indicate that compliance is indeed assured, and by a large enough margin to allow for approximations in the modelling.

3.5.4 Control measures

Live work at 11 kV is compliant with the High AL (and also the sensory effects ELV, and probably with the Lower Action Level), so no control measures are needed.

This work triggers the procedures for identifying staff with AIMDs and pregnant staff.

3.5.5 Triggers for reassessment

Currents greater than 400 A.

3.5.6 Assessment performed by

John Swanson, National Grid, 22/6/16. Based on measurements performed in 1990s and calculations from first principles.

3.6 Live work at 11 kV: modelling annex

Magnetic field

Consider a linesman standing vertically with the current passing across their body horizontally. A horizontal cross section through the linesman will be an oval, and the magnetic field, passing vertically through this cross-section, will induce a current circulating round it. We approximate this cross-section as a rectangle, of the same extent as the linesman measured away from the current, but of infinite extent in the direction parallel to the current.

Cross-section through horizontal plane:

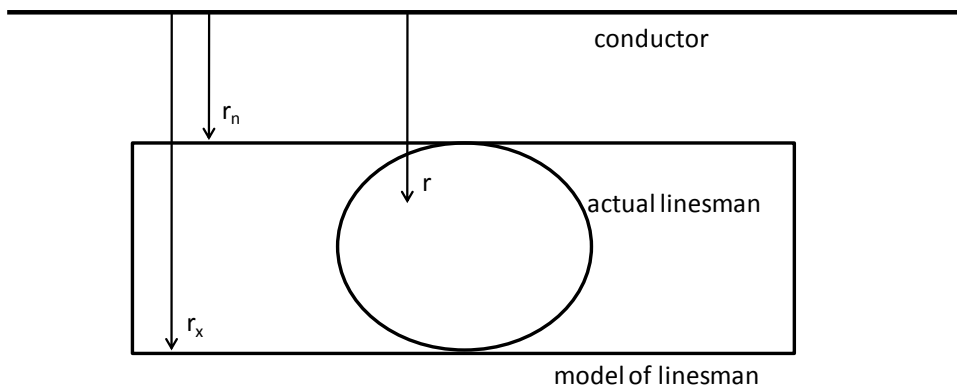

The magnetic field induces a current circulating in this cross-section, and because it is larger than the actual, oval, cross-section of the linesman, the current induced can only be larger than the true current. In fact, once the extent parallel to the current is large compared to the perpendicular direction, the induced current does not increase further.

The induced current is a maximum in one direction at the near point of the cross-section, r_n , and falls with distance, passing through zero at a point defined as r_0 and increasing in the other direction to the far point r_x . Relative to this zero point, the induced field is derived from Maxwell's equation:

$$e_r = -\omega \int_{r_0}^r B_r dr$$

For a single current

$$B_r = \frac{\mu_0 I}{2\pi r}$$

Giving

$$e_r = \frac{-\omega \mu_0 I}{2\pi} \ln \frac{r}{r_0}$$

As the linesman's body is isolated, the current from r_n to r_0 must equal that from r_0 to r_x , which, for uniform conductivity, means:

$$\int_{r_n}^{r_0} e_r dr = - \int_{r_0}^{r_x} e_r dr$$

which gives

$$\ln r_0 = \frac{r_x \ln r_x - r_n \ln r_n}{r_x - r_n} - 1$$

The maximum induced field occurs at r_n and is thus

$$e_{r_n} = \frac{\omega\mu_0 I}{2\pi} \left(\frac{r_x}{r_x - r_n} \ln \frac{r_n}{r_x} - 1 \right)$$

(note that the sign of this expression, which is positive, is in fact arbitrary as it depends on the definition of the direction of the current).

We take, as a worst case, $r_n=8$ mm (5 mm separation from the surface of a 6 mm diameter conductor), and r_x-r_n (the thickness of the linesman) =0.4 m. For the health effects ELV, applicable to the body, therefore, of 800 mV/m rms, $I=4.2$ kA. This is so far above any possible current that compliance is demonstrated even allowing for the approximations in this analytical calculation.

Electric field

We approximate the linesman as an infinite parallel-sided slab of thickness t positioned between two conductors.

Cross-section through vertical plane:

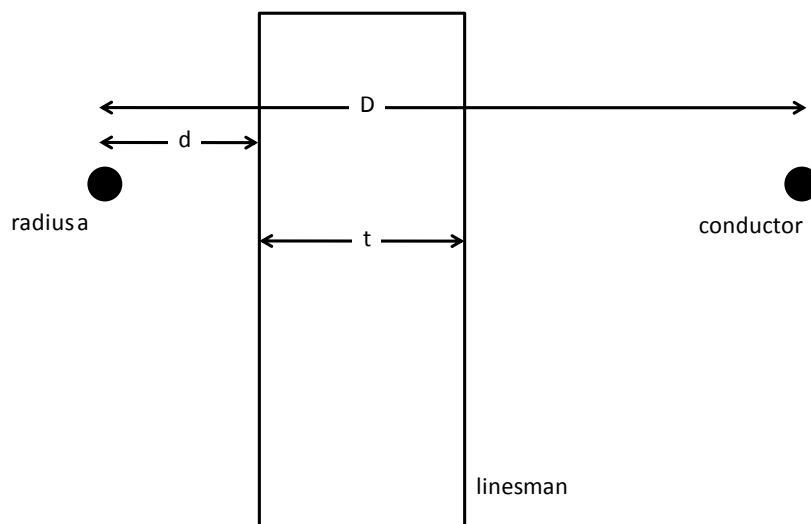

The approximation that they are infinite vertically (perpendicular to the plane of the conductors) is clearly reasonably good; the approximation they are infinite parallel to the conductors is not, but as quantities are calculated per unit length, this makes little difference. The capacitance per unit length to each conductor (radius a and distance d from the conductor centre to the closer surface of the linesman) is

$$C = \frac{2\pi\epsilon}{\ln \frac{d + \sqrt{d^2 - a^2}}{a}}$$

The electric fields produced by the conductor and perturbed by the presence of the linesman can be modelled by a line charge λ per unit length within the conductor, offset by a distance

$$\frac{a^2}{d + \sqrt{d^2 - a^2}}$$

from the centre of the linesman towards the linesman, and matched by an image charge $-\lambda$ within the linesman. The maximum electric field produced by these charges occurs on the horizontal line from conductor to linesman and is given by

$$E = \frac{\lambda}{\pi\epsilon_0} \frac{1}{\sqrt{d^2 - a^2}}$$

The induced electric field is simply

$$e = \frac{\omega\epsilon_0 E}{\sigma}$$

The maximum induced electric field occurs when the linesman is practically touching one conductor. The gap to the other conductor is then larger, giving a lower capacitance, and the current, determined by the two capacitances in series, is effectively limited just by this capacitance to the further conductor, for which

$$d = D - t$$

The charge per unit length and the voltage are related by the capacitance

$$\lambda = VC$$

Putting all these results together gives

$$e_{max} = \frac{2V\omega\epsilon_0}{\sigma\sqrt{d^2 - a^2} \ln \frac{2(D - t)}{a}}$$

Using the same worst-case parameters $d=8$ mm (5 mm separation from the surface of a 6 mm diameter conductor), $a=3$ mm, t (the thickness of the linesman) =0.4 m, D (the separation of the conductors) =1 m, and a typical value for the conductivity 0.2 S/m:

$$e_{max} = 0.007 \text{ V/m}$$

Again, this is so far below the Health ELV (0.8 V/m) and also the sensory ELV (0.1 V/m) that compliance is demonstrated even allowing for the approximations in the calculation.

3.7 Approach to a single insulated conductor

3.7.1 Description of activity

Various scenarios allow close approach to an insulated conductor:

- Cables in cable tunnels (also treated specifically in 3.16 below);
- Cable terminations and transformer tails in high-voltage substations;
- Insulated cables in distribution substations;
- Supplies to motors or other large industrial equipment (if supplied by unbundled conductors) etc.

Examples of some of these are shown in the following photos:



These activities all involve essentially the same exposure geometry and are treated generically here.

3.7.2 Summary of exposures

Electric fields are not relevant because the cables have conducting sheaths.

For magnetic fields, a worst case is assessed by considering a single conductor (i.e. assuming that the other two phases are far apart compared to the diameter of the conductor) and by assuming that the conductor is infinitely long.

The field is therefore calculable as

$$B = \frac{\mu_0 I}{2\pi r}$$

Following CENELEC, it is assumed that the minimum approach of the brain to the surface of a conductor is 40 mm (10 mm skull plus 30 mm hard hat), or 10 mm for the rest of the body or for the brain if no hard hat is worn. On this basis, the fields produced at the relevant distances from worst-case conductors at transmission voltages are:

	Cable	Current rating	Radius of the cable	Magnetic with rated current		
				field at contact with outer surface of conductor	at contact + 10 mm	at contact + 40 mm
examples given by CENELEC	400 V	400 A	20 mm	4 mT	2.7 mT	1.3 mT
	11-33 kV	1200 A	60 mm	4 mT	3.4 mT	2.4 mT
	90 kV	1000 A	42 mm	4.8 mT	3.8 mT	2.4 mT
	220 kV	1500 A	60 mm	5.0 mT	4.3 mT	3.0 mT
	400 kV	1800 A	75 mm	4.8 mT	4.2 mT	3.1 mT
limiting case		1000 A	23 mm		6.0 mT	
		2000 A	57 mm		6.0 mT	

3.7.3 Assessment of exposures

In line with the Procedure, assessment is performed for the maximum continuous rating.

The Low AL can be exceeded for close approach to such cables. The High AL, however, can not be exceeded. Even when the Low AL is exceeded, it is unlikely that the sensory effects ELV is exceeded, given the conservative nature of the assumptions made (single conductor, infinite length) and the non-uniformity of the field. Likewise, if the High AL were exceeded, it is unlikely that the health ELV would be exceeded.

It should be noted that where conductors are bundled, the fields are reduced considerably compared to the worst case of a single isolated conductor considered here, and compliance is achieved by a greater margin.

With multiple circuits and conductors, as often found in tunnels and vaults, the limiting case is still to consider a single isolated conductor.

3.7.4 Control measures

No control measures needed.

This applies to all cable installations, including cable tunnels, sealing ends and tails in substations, etc.

This exposure scenario will sometimes trigger the procedures for identifying staff with AIMDs and pregnant staff.

3.7.5 Triggers for reassessment

Cables that exceed the worst-case parameters assumed above by a sufficient margin to increase fields to the High AL, 6 mT.

The final rows of the table give a scenario producing 6 mT at 10 mm from the conductor surface and indicates that compliance is achieved for a rating of 2000 A as long as the conductor outer diameter is more than 113 mm. The following graph provides the full range of scenarios corresponding to 6 mT at 10 mm.

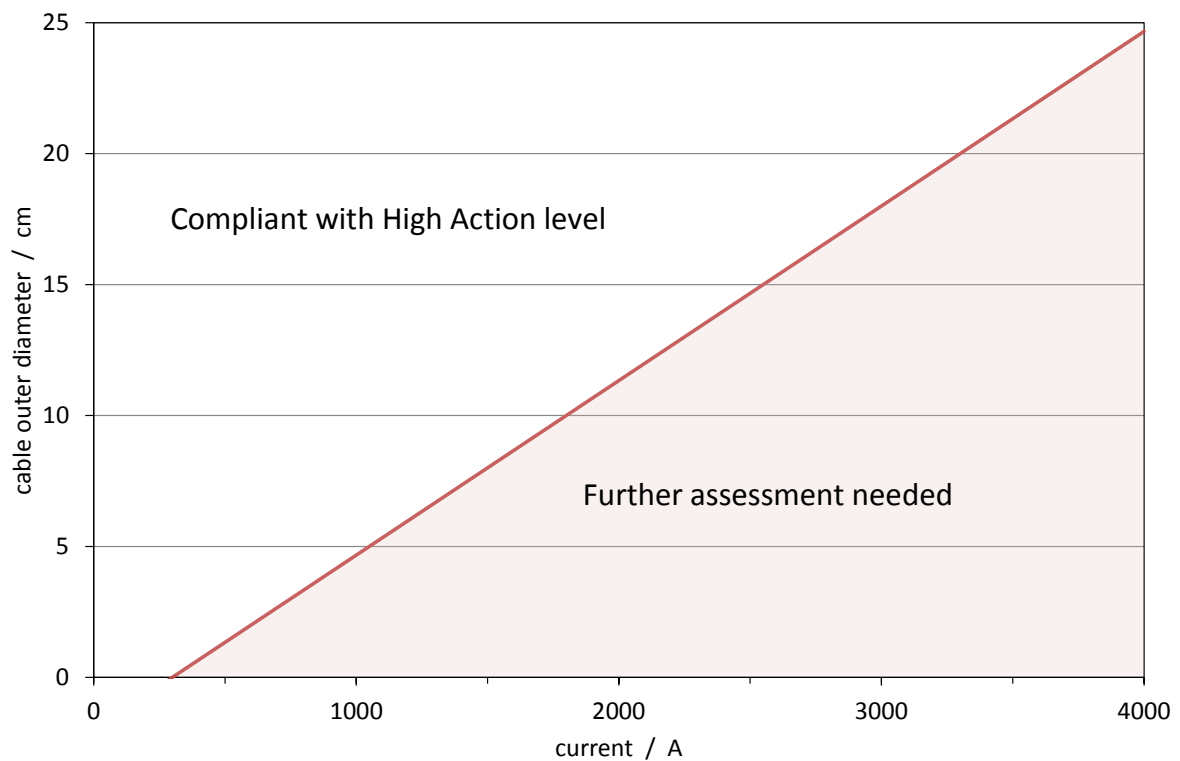

All conductors that meet with the above criteria are compliant.

Any conductor that does not meet the above criteria will not necessarily be non-compliant but should be referred to the EMF Specialists for further assessment.

3.7.6 Assessment performed by

John Swanson, National Grid, 22/6/16. Based on calculations from first principles. Photos added 16/4/18.

3.8 Substations 275 and 400 kV and above, HV compounds, not including SVCs

3.8.1 Description of activity

Substations contain transformers, switchgear, monitoring and control equipment, and busbars or underground cables connecting all of these.

In some substations, there is a separate high-voltage compound within the overall substation perimeter. In others, once the outer perimeter is entered, you are within the high-voltage areas. This section deals with the actual high-voltage compound; any area outside the HV compound but within the overall substation perimeter is considered separately in section 3.10.

3.8.2 Summary of exposures

Particular items of equipment, such as transformers and switchgear, do not produce significant fields. The maximum fields come from the busbars and cables.

Electric fields

The highest fields come in a substation with the highest voltage, 400 kV.

The maximum fields come under busbars, and specifically under arrangements where adjacent busbars have the same phase rather than different phase (which would lead to some cancellation and lower fields). An exercise was undertaken in the 1970s to identify the instances where this effect was most extreme and detailed measurements were made at the site thus identified, Hinkley Point substation in Somerset. (These measurements were made at 1.8 m (head height) above ground instead of the 1 m which is now recognised as more appropriate for assessing the effect of a non-uniform electric field on the body.)

Contour plot over whole HV compound:

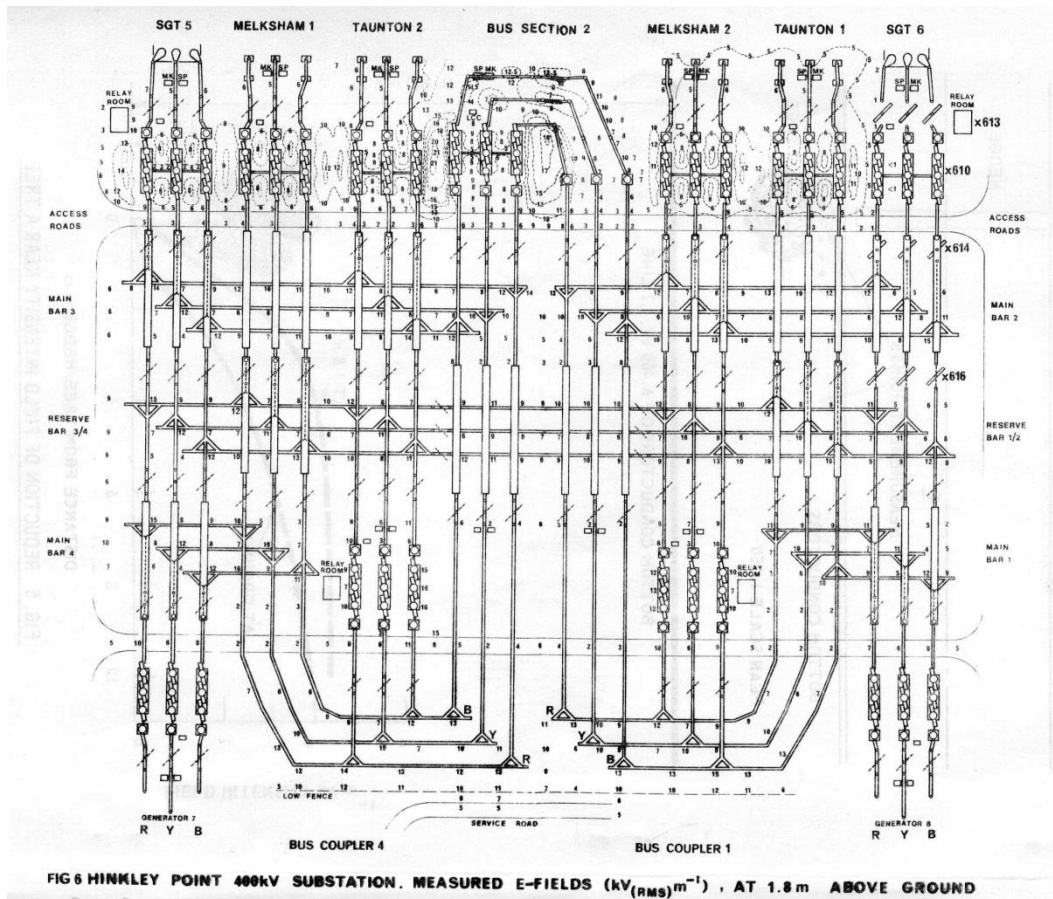

Enlargement of area with highest fields:

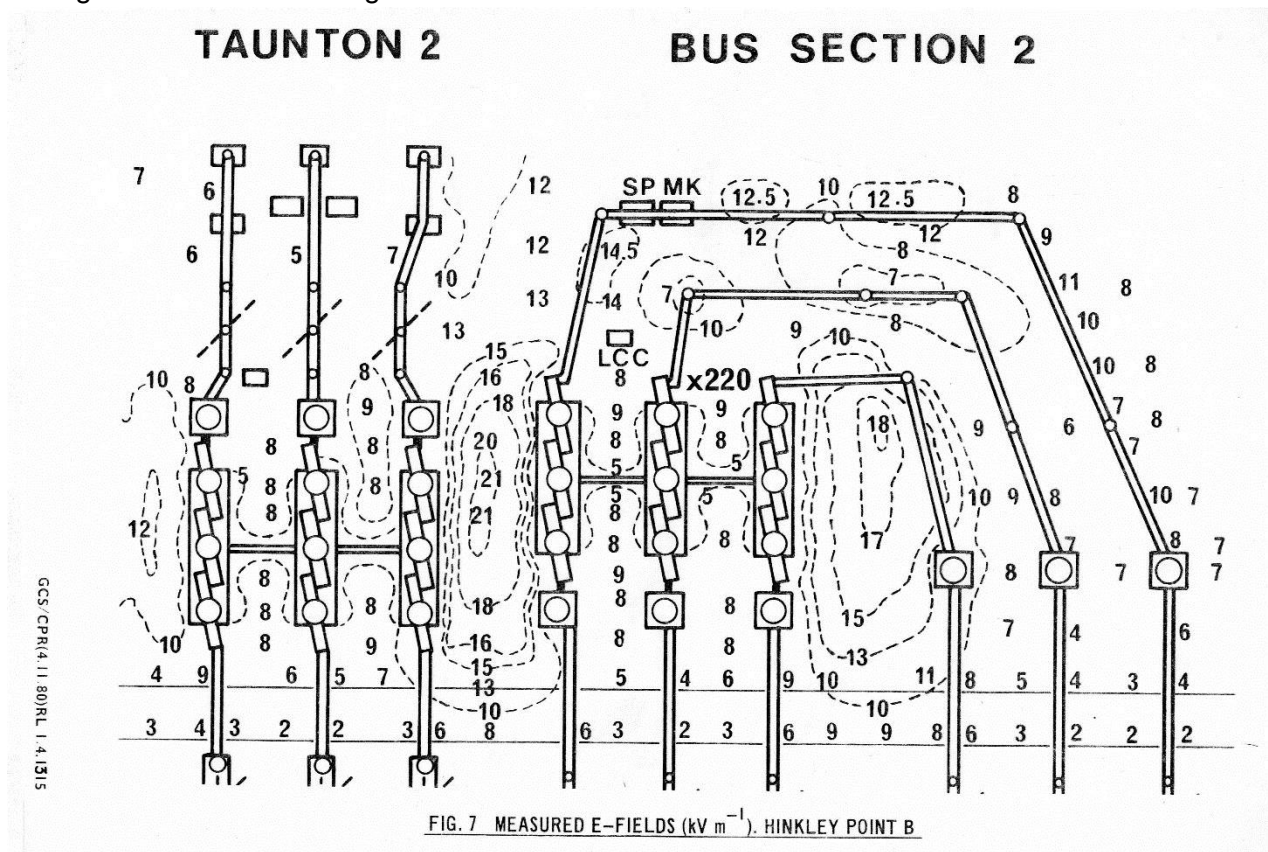

Magnetic fields

The highest exposures come from transformer tails and cable sealing ends, which are treated according to the provisions of “single conductors” above. Air-cored reactors are treated separately and are not encompassed by this section.

3.8.3 Assessment of exposures

Electric fields

The maximum field measured, in the design of substation expected to produce the maximum field, was 21 kV/m. This is more than the High Action Level 20 kV/m. However, it is less than the ELV. Further, it was measured at 1.8 m above ground; the field at 1 m above ground would be lower, and almost certainly below the Higher Action Level.

Note that the highest field arises where adjacent busbars have the same phase. A more extreme example of this can occur with series compensators and is considered separately in that section.

Magnetic fields

The highest exposures come from transformer tails and cable sealing ends, which are treated according to the provisions of “single conductors” above. Fields are above the Low AL but below the High AL.

3.8.4 Control measures

No additional control measures needed.

This work involves the risk of microshocks, which are controlled through provision of appropriate footwear, gloves, harnesses, and provision of advice, including the facility to report situations giving particular concern.

This work triggers the procedures for identifying staff with AIMDs and pregnant staff.

3.8.5 Triggers for reassessment

Any designs of substations with lower clearance for the busbars.

3.8.6 Assessment performed by

John Swanson, National Grid, 22/6/16. Based on systematic measurements in 1970s validated by subsequent ad hoc measurements.

3.9 Substations 275 and 400 kV and above, Gas Insulated Switchgear (GIS)

3.9.1 Description of activity

GIS substations are a special case of substations in general. The assessment of substations in general does cover GIS, but GIS is also treated specifically here.

3.9.2 Summary of exposures

Particular items of equipment, such as transformers and switchgear, do not produce significant fields. The maximum fields come from the busbars and cables.

Electric fields

The enclosure of the GIS busbars or switchgear eliminates external electric fields.

Magnetic fields

Transformer tails and cable sealing ends, which may not be GIS, are treated according to the provisions of “single conductors” above.

For all GIS equipment, the greater separation from the current-carrying conductor enforced by the gas enclosure ensures that magnetic field exposures are significantly lower than for solid-insulation conductors.

3.9.3 Assessment of exposures

All exposures are compliant, by a larger margin than for air-insulated substations.

3.9.4 Control measures

No additional control measures needed.

This work triggers the procedures for identifying staff with AIMDs and pregnant staff.

3.9.5 Triggers for reassessment

Any designs of substations with lower clearance for the busbars.

3.9.6 Assessment performed by

John Swanson, National Grid, 20/4/17. Based on measurements in 1990s.

3.10 Substations 275 and 400 kV and above, areas outside HV compounds

3.10.1 Description of activity

Substations contain transformers, switchgear, monitoring and control equipment, and busbars or underground cables connecting all of these.

In some substations, there is a separate high-voltage compound within the overall substation perimeter. In others, once the outer perimeter is entered, workers are within the high-voltage areas. This section deals with those areas within the overall substation perimeter but outside the high-voltage compound.

Access to such areas is not necessarily confined to the company's own staff or to contractors forming part of a formal working party but can include cleaners, grounds maintenance staff, post and parcel deliveries, etc.

3.10.2 Summary of exposures

The following table shows measured fields in areas outside the HV compounds in one particular substation:

Location Identification	Location Description	Electric Field (kV/m)	Magnetic Field (μT)
400/275kV substation			
1	Corner of Road nr MSC2	2.2	2.86
2	Busbars to MSC 2, middle of road	9.2	10.10
3	Middle of Road by Capacitors	4.4	10.28
	Middle of Road by Resistors	2.1	27.24
	Middle of Road by Reactor coils	1.5	55.60
	Fence Line by Reactor coils	N/A	300.00
4	Busbars to X510, middle of road	6.3	7.64
5	SGT5 cable ducts	N/A	75.00
6	Busbars to X105, middle of road	4.8	16.42
7	Busbars to X305, middle of road	4.1	7.24
8	Busbars to X705, middle of road	4.5	3.56
9	Cable Duct	N/A	78.04
10	Busbar crossover construction bay	12.7	1.36
11	Busbar crossover construction bay	6.3	1.56
12	Cables	N/A	3.86
13	Cables / Overhead Line	2.3	12.00
14	Gate	N/A	3.80
15	Overhead Line	0.7	3.85
16	Office / Overhead Line	1.2	3.82
17	Substation Gate	N/A	2.64

The following graph shows the measured magnetic field around but outside the perimeter fence of the 400 kV compound of the same substation:

Appendix A

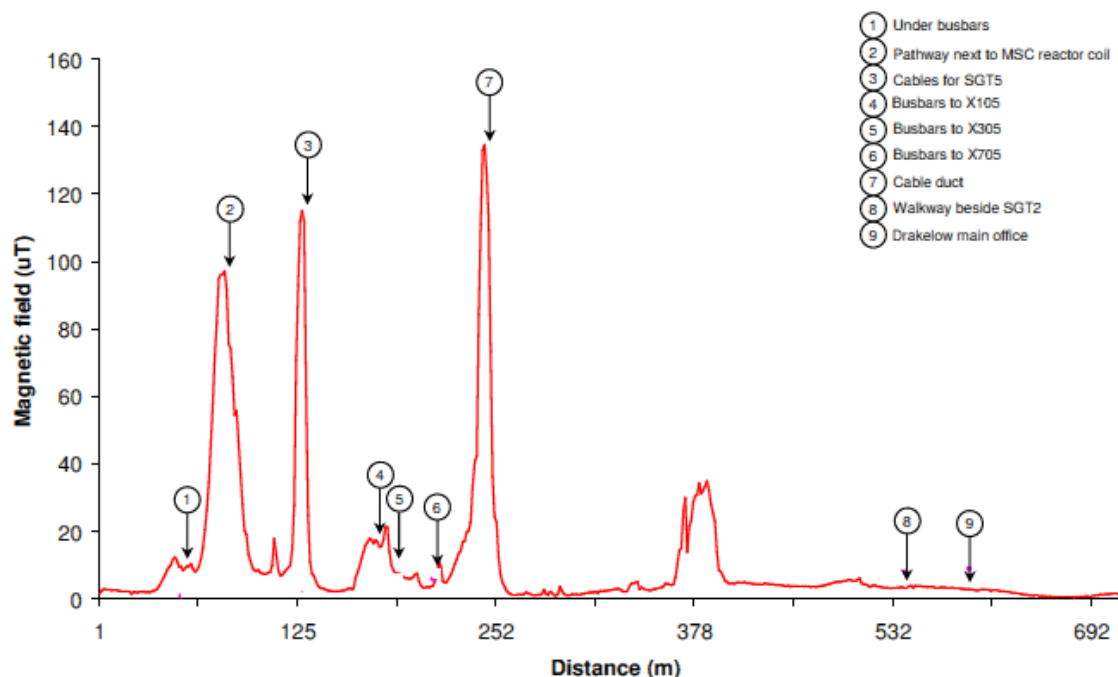

3.10.3 Assessment of exposures

In this substation, magnetic fields greater than 100 µT and electric fields greater than 6 kV/m were encountered outside the HV compounds.

The fields inside the HV compound will always be higher than outside, so given that the separate assessment shows that fields inside the compounds are compliant with the Directive, so will the fields outside be. However, fields outside, in at least some places, are large enough to cause potential interference with AIMDs.

Other substations have been assessed where the fields outside the HV compounds were not large enough to exceed the AIMD interference thresholds, but these measurements show that such areas must, in general, be considered to exceed these levels unless a specific assessment demonstrates otherwise.

3.10.4 Control measures

These areas trigger the procedures for identifying staff with AIMDs and pregnant staff, with the option of a site-specific survey to remove this requirement in some cases.

No other controls needed.

3.10.5 Triggers for reassessment

Any designs of substations with lower clearance for the busbars.

3.10.6 Assessment performed by

John Swanson, National Grid, 22/6/16. Based on measurements performed in 2010s.

3.11 Substations 33 kV-132 kV, not including SVCs

3.11.1 Description of activity

Substations contain transformers, switchgear, monitoring and control equipment, and busbars or underground cables connecting all of these.

In some substations, there is a separate high-voltage compound within the overall substation perimeter. In others, once the outer perimeter is entered, workers are within the high-voltage areas.

3.11.2 Summary of exposures

Particular items of equipment, such as transformers and switchgear, do not produce significant fields. The maximum fields come from the busbars and cables.

A comprehensive measurement exercise was conducted in 1994 on around twenty substations in ten licence areas and forms the basis for this assessment.

Electric fields

The highest electric field found in a 132 kV substation was 6.1 kV/m.

Magnetic fields

The maximum fields come from the “transformer tails” where insulated, single-phase conductors run vertically from ground level to a transformer or busbars, and can be approached closely. These were assessed above under “single conductors”. Fields can exceed the Low AL but do not exceed the High AL.

In the measurement exercise, the highest fields were found on the 33 kV tails of 132 kV/33 kV transformers. The worst-case exposure scenario (found in at least three licence areas) was:

- Transformer rating 90 or 100 MVA
- Three 33 kV tails per phase
- Measured fields on surface of one tail 500-1000 μT
- Field on surface of one tail (scaled to rated load) 2400 μT

(strictly speaking these are the fields at a location as close to the surface of the conductor as the coil of the measuring instrument can be placed)

This is consistent with calculations for $I=600$ A per tail and $r=50$ mm (treating each tail in isolation and ignoring the effect of the others).

3.11.3 Assessment of exposures

Electric fields

Fields in substations of 132 kV and below do not exceed the Low Action level.

Magnetic fields

For a maximum transformer rating of 100 MVA with three tails per phase, the maximum field on the surface of the tail is 2400 μT . This assessment has been based on the assumption that the maximum continuous, non-emergency, transformer rating is 120 MVA, giving a field of 2900 μT . This is more than the Low Action level but less than the uniform field equivalent to the Sensory Effects ELV. As the field is actually non-uniform, compliance with the equivalent uniform field guarantees actual compliance.

Note that this case is already covered by the analysis of close approach to a single insulated conductor, section 0; the data presented here gives extra reassurance.

3.11.4 Control measures

For electric fields the Low Action level is not exceeded and for magnetic fields the High AL (and also the Sensory Effects ELV) is not exceeded, so no control measures are needed. This work triggers the procedures for identifying staff with AIMDs and pregnant staff.

No other controls needed. (Unlike 275/400 kV substations, the electric field is below the Low Action Level, so the microshock provisions are not triggered, and the magnetic field is below the Sensory Effects ELV.)

3.11.5 Triggers for reassessment

Any designs of substations with lower clearance for the busbars.

Transformers with continuous ratings greater than 120 MVA.

3.11.6 Assessment performed by

John Swanson, National Grid, 22/6/16. Based on measurements performed in 1990s.

3.12 Air-Cored Reactors

3.12.1 Description of activity

Certain substations contain large air-cored reactors. The commonest (and largest) type is part of a Static Var Compensator (SVC) and this is therefore used as a convenient label for the plant group, but should be understood as encompassing all air-cored reactors.

The current through an SVC is variable and controlled by thyristors.

3.12.2 Summary of exposures

Exposures can be assessed by calculation or by measurement.

Calculations can be performed numerically for any desired location, or analytically on the axis of a single coil.

Measurements are straightforward when performed at rated load, when the waveform is a sine wave. At less than full load, when the waveform is chopped by the thyristors, considerable harmonics are present. This causes problems in scaling to full load, as the meters used to measure the field and the current may not weight harmonics in the same way. The assessments presented in this section are either performed at full rated load or have been appropriately scaled. Short-term ratings are used too rarely to justify requiring compliance.

It is not possible to identify a single worst case design. Different designs need assessing separately. Assessments of the designs in use in the UK are included in the Annex to this section.

3.12.3 Assessment of exposures

- **GEC-Alstom 150 MVA design** (St John's Wood): field exceeds High AL (and almost certainly health effects ELV). However, these fields are confined to the buildings enclosing the coils. Outside these buildings, the fields could exceed the Low AL but not the High AL.
- **GEC-Alstom 75 MVA design** (Exeter etc): the field on the axis of the coil exceeds the High AL at full rating at heights above 0.8 m. The field is vertical and therefore less well coupled to the body, but will probably nonetheless exceed the ELV.
- **Siemens design and RSVCs**: the design prevents close approach to the coils and therefore to the area where high magnetic fields could be found.
- **Sellings/Ninfield design**: does not exceed the Low AL.

3.12.4 Control measures

Where identified as necessary, a warning barrier should be erected at the identified location corresponding to the approximate contour of the High Action Level, 6 mT. This applies only to:

- **St John's Wood:** the building enclosing the TCR coils
- **Cellarhead, Exeter, Lovedean, Mannington, and Willington:** the outer diameter of each of the three pairs of TCR coils.

This should be of a design that is not confused with high-voltage safety barriers. A single strand of plastic chain-link has been found suitable.

Such barriers and warning signs have been put in place by National Grid at the sites identified in this section. These therefore constitute sufficient controls measures and no additional measures are required.

This work triggers the procedures for identifying staff with AIMDs and pregnant staff.

3.12.5 Triggers for reassessment

This assessment covers all existing installations. For new installations, manufacturers are required by the relevant Technical Specification to provide data on magnetic fields and to ensure that access is not possible to areas exceeding the High AL.

3.12.6 Assessment performed by

John Swanson, National Grid, 22/6/16. Based on measurements performed on various occasions from 1990s to 2016. Discussion of harmonics added 16/4/18.

3.13 Air-cored reactors Annex: assessment of specific designs

3.13.1 The GEC Alstom 75 MVA SVC design

Cellarhead, Exeter, Lovedean, Mannington, and Willington



The magnetic field of this design of SVC, at 1.3 m above ground and scaled to the rating (4500 A), has been measured and is shown in the following contour plot:

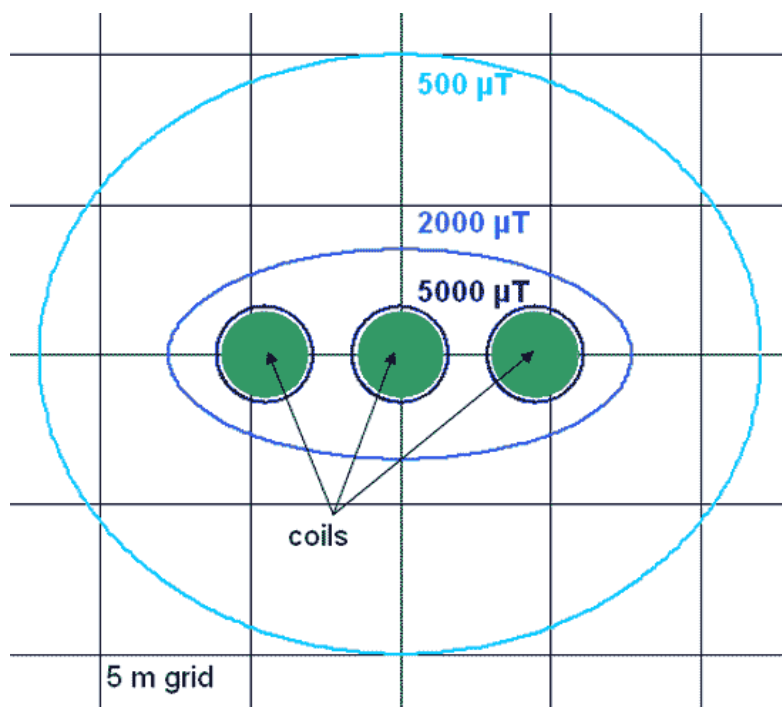

The variation of field with height under the central coil was also measured:

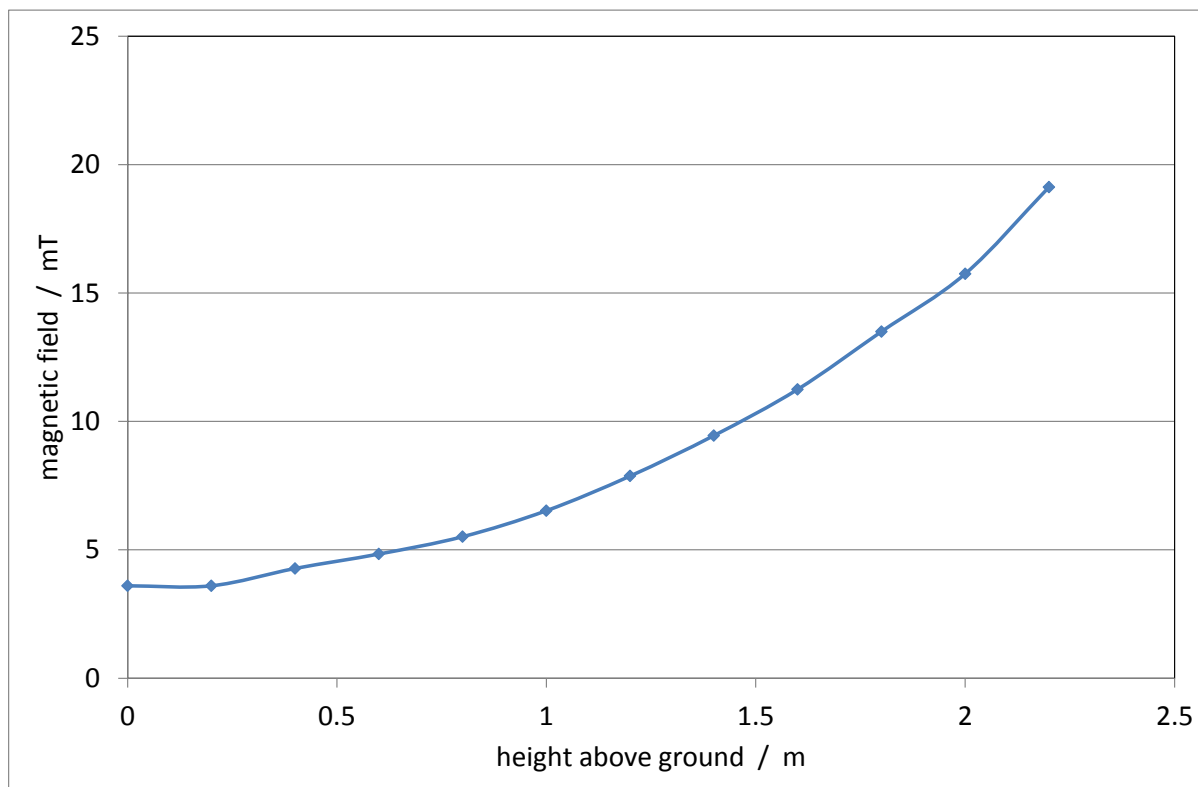

The field under the outer two coils is approximately 10% lower.

The filter coils and surge coils are smaller and do not exceed the limits.

3.13.2 The GEC Alsthom 150 MVA design

St John's Wood SVC1 and SVC3

This design is the largest SVC currently on the National Grid system and has been assessed by measurement.

TSC inrush coils

The maximum field at chest height at the circumference of the coils is below 2 mT. The maximum field at head height on the axis of the coils is estimated not to exceed 4 mT.

Filter coils

The maximum field at head height on the centre line of the coils is 2.9 mT.

TCR coils

The red line on the following plan shows the 2 mT contour. At the time these measurements were performed, 6 mT (the High Action Level) was not a relevant figure and was not specifically assessed, but the 6 mT contour can safely be extrapolated to fall within the building enclosing the coils.

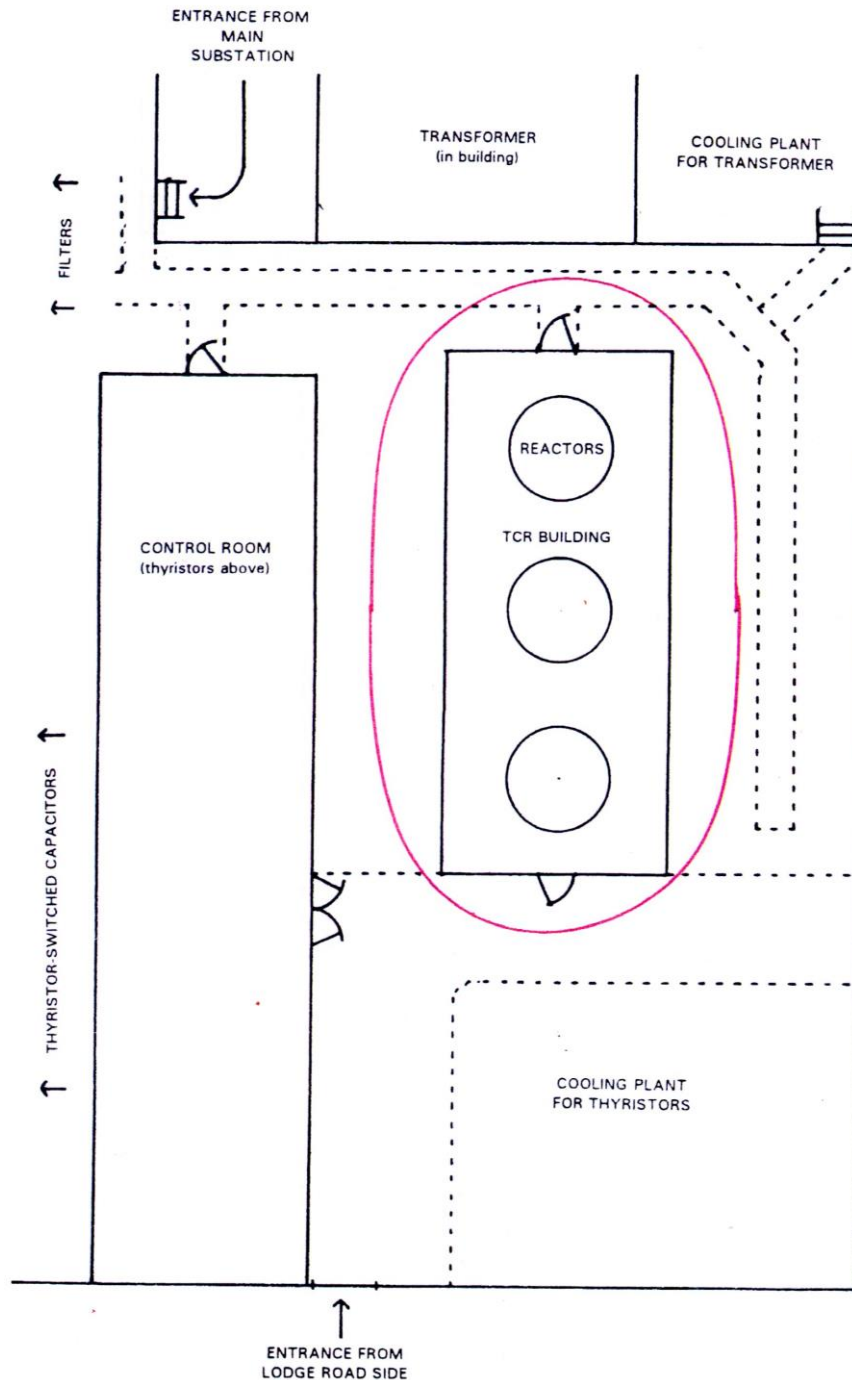

The maximum field in this instance, at head height directly beneath one of the coils, was of the order of 20 mT.

3.13.3 The Siemens design

Drakelow, Feckenham, Harker and Pelham

The coils are mounted close to ground level and access is prevented by a fence. This fence prevents access to areas where high magnetic fields are produced. Measurements were

performed at full load at locations around these fences. The highest field measured was 820 μT , at location 4.

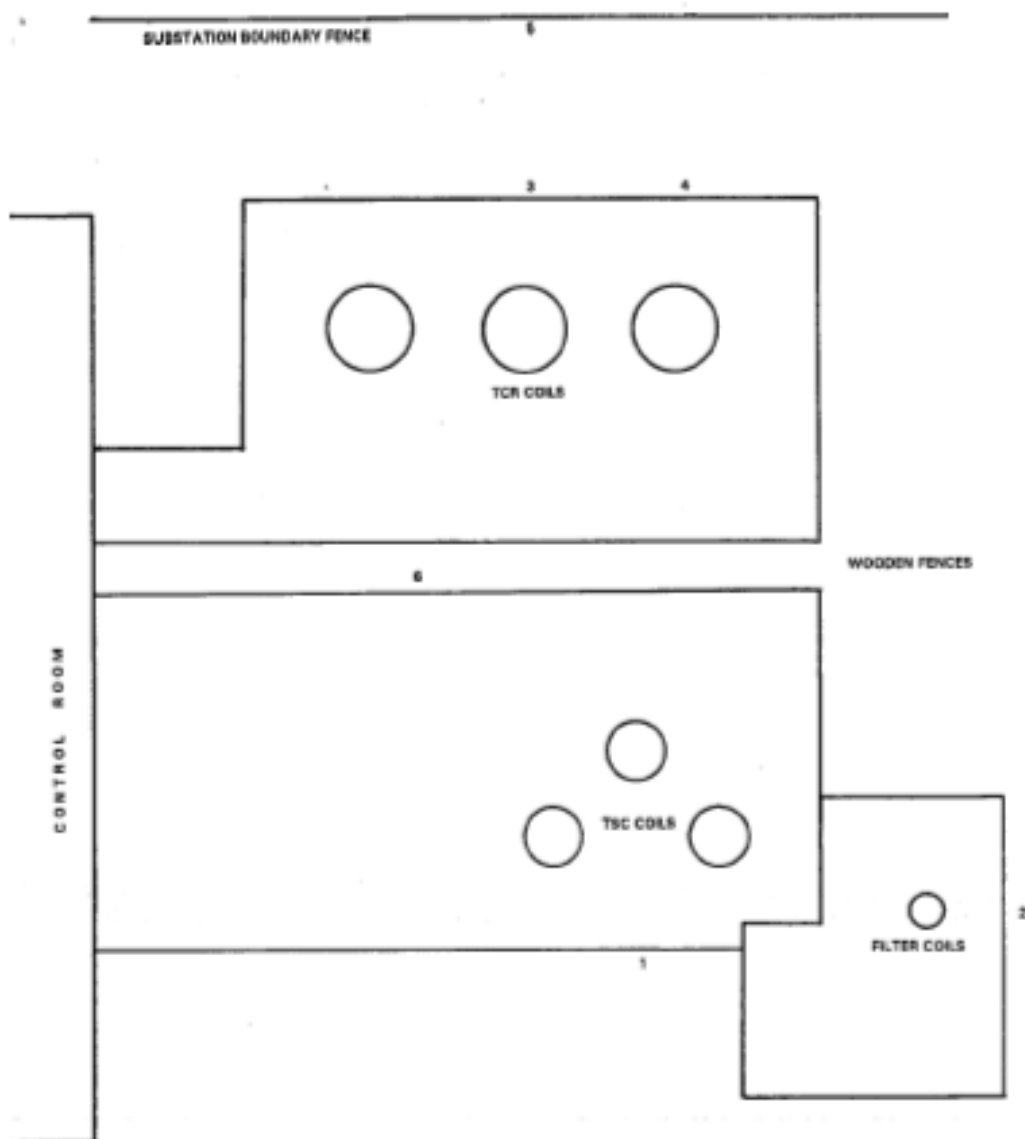

Figure 1
PLAN OF FELHAM SVCS
SVCS has the same layout
Numbers indicate positions of measurements referred to in text

3.13.4 Saturable reactor design

Sellindge, Ninfield

These designs comprise a saturated reactor plus various filter and bypass coils. (The Sellindge site contains other air-cored coils associated with the converter rather than specifically the reactor and these are covered in the next subsection.)

The saturated reactor has an iron core and in normal operation produces lower fields than an air-cored reactor. The highest field measured against the outside of the building containing it was 155 μT and against the reactor itself inside the building, around 200 μT .

The fields measured from the various air-cored reactors are as follows:

Reactor	A	B	C	D	bypass
Field (μT) at:					
ground level	500	500	255	360	460
1 m	900	900	450	680	850
2 m	1400	1400	710	1100	1400

The operation of these coils is such that the fields are normally constant. The bypass coil can vary, but principally only for short durations associated with switching or with faults in the DC link.

3.13.5 Coils associated with HVDC

Sellindge contains filter coils for the compensator. Because these are at 400 kV they are mounted relatively high above ground and hence do not produce high fields in regions occupied by a person. The highest field measured from any of the various filter coils (in fact from the "C" type) was 120 μT at 2 m above ground.

The convertor equipment at Sellindge is considered separately in section 3.28.

3.13.6 RSVCs, ABB variant

Coventry Penn, Hams Hall & Oldbury

3.13.7 RSVCs, Alstom variant

Pyle, Elstree, Bridgewater, Iron Acton

Relocatable SVCs have the coils behind a high-voltage fence (and often elevated significantly above ground as well) so access to the areas where high fields would be found is not possible. See for example the following illustrative photos:



3.13.8 Effect of harmonics on assessment

As noted above, the currents in SVC coils are thyristor-chopped and contain harmonics, which should be included in a complete assessment. The High Action Levels are inversely proportional to frequency, meaning that any increase in harmonic currents have worse impact on the assessment of compliance than a reduction in the fundamental. This means that, as the current is reduced from maximum, the fact that harmonic currents are introduced could in principle outweigh the reduction in the total current, and the worst case for compliance would be some fraction of the rating rather than the rating itself as assumed in the assessments above. However, the full assessment needs to take account of the phase relationship between the various harmonics to determine if this does indeed happen or not.

Full data on harmonics with phase relationships is not currently available. Data on harmonic levels, but without phase relationships, is available for one specific SVC design. Based on this, if the harmonics are taken as having random phase relationships, the addition of harmonic currents does not outweigh the reduction in the total current, so the worst-case assessment remains the rating as assumed above. If the harmonics were assumed to have the worst-case phase relationship, which is unlikely in practice, the converse is true, and the worst case becomes a firing angle of approximately 100° , compared to the 90° that represents rating. In that scenario the compliance would be approximately 50% more onerous than for the rating.

Taking account of the unlikelihood that the phase relationships would be worst-case, and the conservative assumptions built into the control measures as discussed above, it is concluded that the control measures (i.e. the location of the fences) provides adequate protection even allowing for harmonics.

3.14 Series Compensators

3.14.1 Description of activity

National Grid has so far installed one series compensator, at Hutton. It includes air-cored reactors, but because these are at 400 kV, they are raised higher above ground than is the case for SVCs:



3.14.2 Summary of exposures

Magnetic fields

The following contour plot is extracted from calculations provided by ABB, the manufacturer:

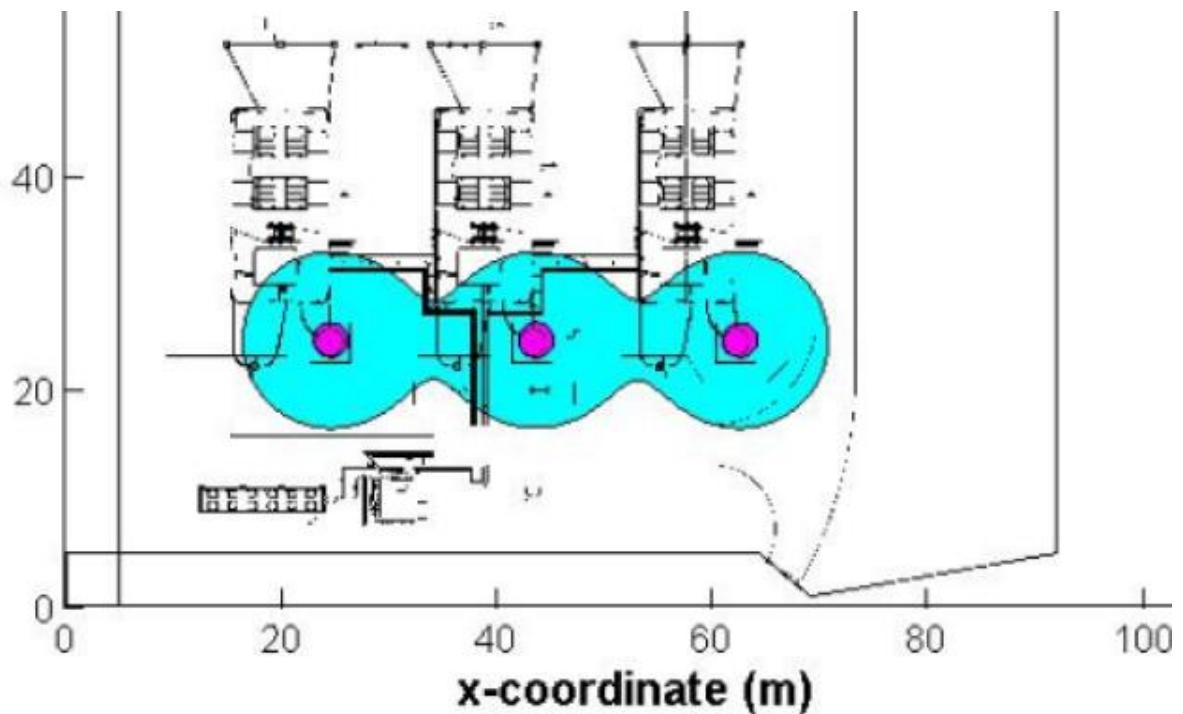

The outer edge of the blue is 100 μ T and the blue/pink boundary is 500 μ T.

Electric fields

The TSC has three capacitor banks, one for each phase. The busbar arrangements for connecting each capacitor bank and for allowing switching mean that there is an area in front of each capacitor bank roughly comprising a square of busbars all of the same phase, as shown on the plan below. This produces a higher electric field than normal substations, because in normal substations, busbars of other phases are also present and provide some cancellation.

The highest electric field measured, at the location shown by the blue spot, was 23.5 kV/m.

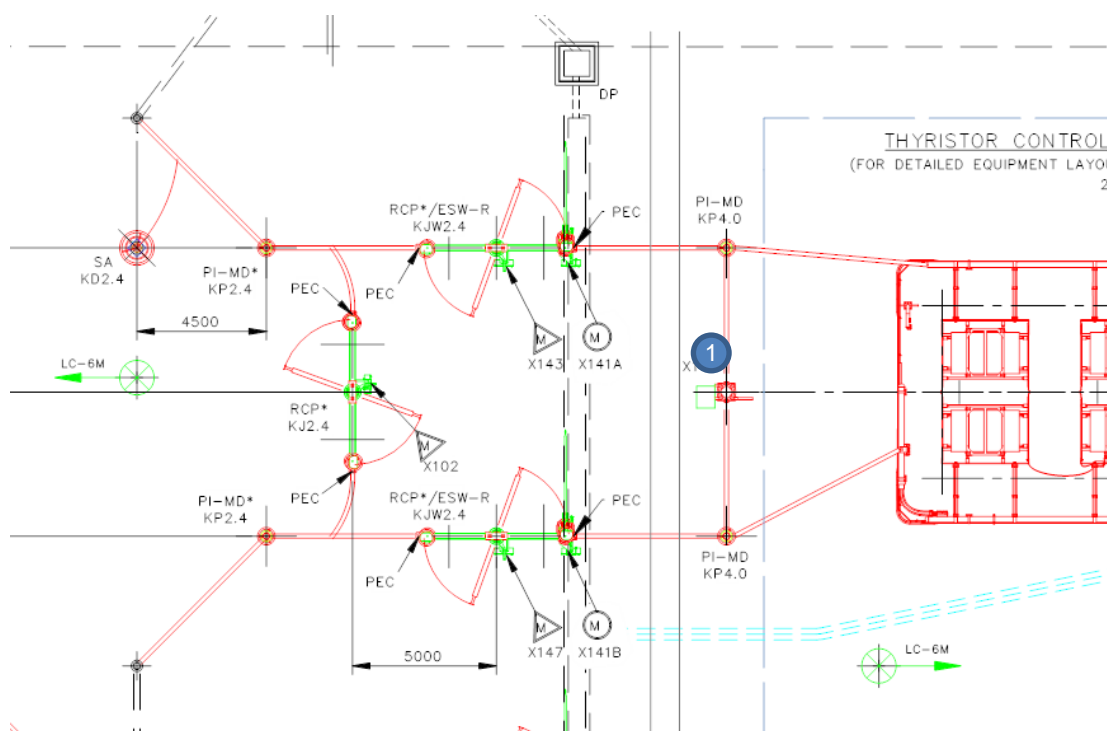

3.14.3 Assessment of exposures

Magnetic-field exposures do not exceed the High AL and probably do not exceed the Low AL.

Electric-field exposures exceed the High AL but do not exceed the field corresponding to the Exposure Limit value, 35 kV/m.

3.14.4 Control measures

None needed.

This activity triggers the provisions for staff with AIMDs and pregnant staff.

This activity triggers the need to put in place measures to manage microshocks.

3.14.5 Triggers for reassessment

For any future new series compensators, the supplier would be required by the TS to provide a magnetic-field assessment.

3.14.6 Assessment performed by

John Swanson, National Grid, 20/4/17. Based on information provided by ABB and by site measurements by Dr Hayley Tripp.

3.15 Substations 11 kV

3.15.1 Description of activity

Final distribution substations transform electricity from 11 kV to 400 V. They can be pole-mounted, ground-mounted outdoors, or indoors.

3.15.2 Summary of exposures

Electric fields are not significant as the largest voltage present is 11 kV.

The highest magnetic fields are produced by indoor substations with old-style open-frame LV Boards mounted on a wall.



Measurements have been made on several such examples in central London, chosen to be likely (because of size and load) to produce the highest fields. The highest field measured in a position where a worker's head or trunk could be positioned was 200 μT .

A spreadsheet was created to model the busbars and allow calculations of the maximum to be made.

For a maximum transformer rating of 1 MVA (ignoring cyclic ratings), where the whole load is assumed to flow through 2 m long busbars with no reduction (an implausible extreme scenario), the 1 mT Low Action level is exceeded at a distance of 0.27 m horizontally from the busbars.

3.15.3 Assessment of exposures

For an extreme case, the highest magnetic field in a place where a worker's head could be present is just equal to the Low Action Level.

3.15.4 Control measures

Exposures are compliant. No controls are needed.

This work triggers the procedures for identifying staff with AIMDs and, in principle, for pregnant staff, though it is unlikely in practice that exposures would exceed the threshold for pregnant staff (360 μT).

3.15.5 Triggers for reassessment

New designs of substation are almost always more compact and therefore produce lower fields. It is unlikely that the existing maximum values would ever be exceeded in the future. Note: if a more extreme scenario is identified, or if account is taken of cyclic ratings, compliance would probably still be ensured against the Sensory Effects ELV and almost certainly against the High Action Level and the Health ELV.

3.15.6 Assessment performed by

John Swanson, National Grid, 22/6/16. Based on systematic measurements in 2010s supplemented by other ad hoc measurements.

3.16 Transmission Cable tunnels

3.16.1 Description of activity



Transmission cables are sometimes installed in underground tunnels, typically circular tunnels, with one three-phase circuit on each side. Variants exist, with the cables bundled in trefoil (though usually still separating at joint positions), more than two groups or circuits, or square cross-section tunnels.

Access whilst the cables are live is possible in at least some circumstances.

3.16.2 Summary of exposures

A typical geometry is:

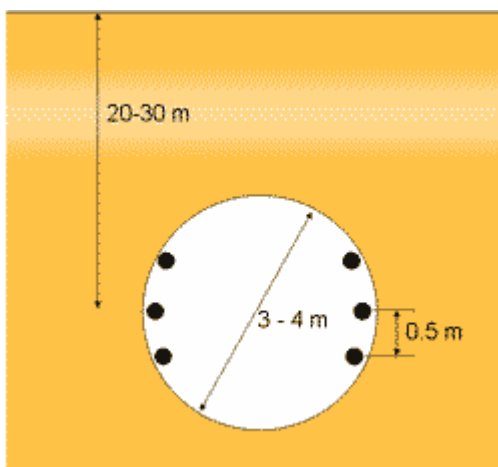

A contour plot for a load of 2400 A showing the 1 mT and 6 mT (Low Action Level and High Action Level) contours is:

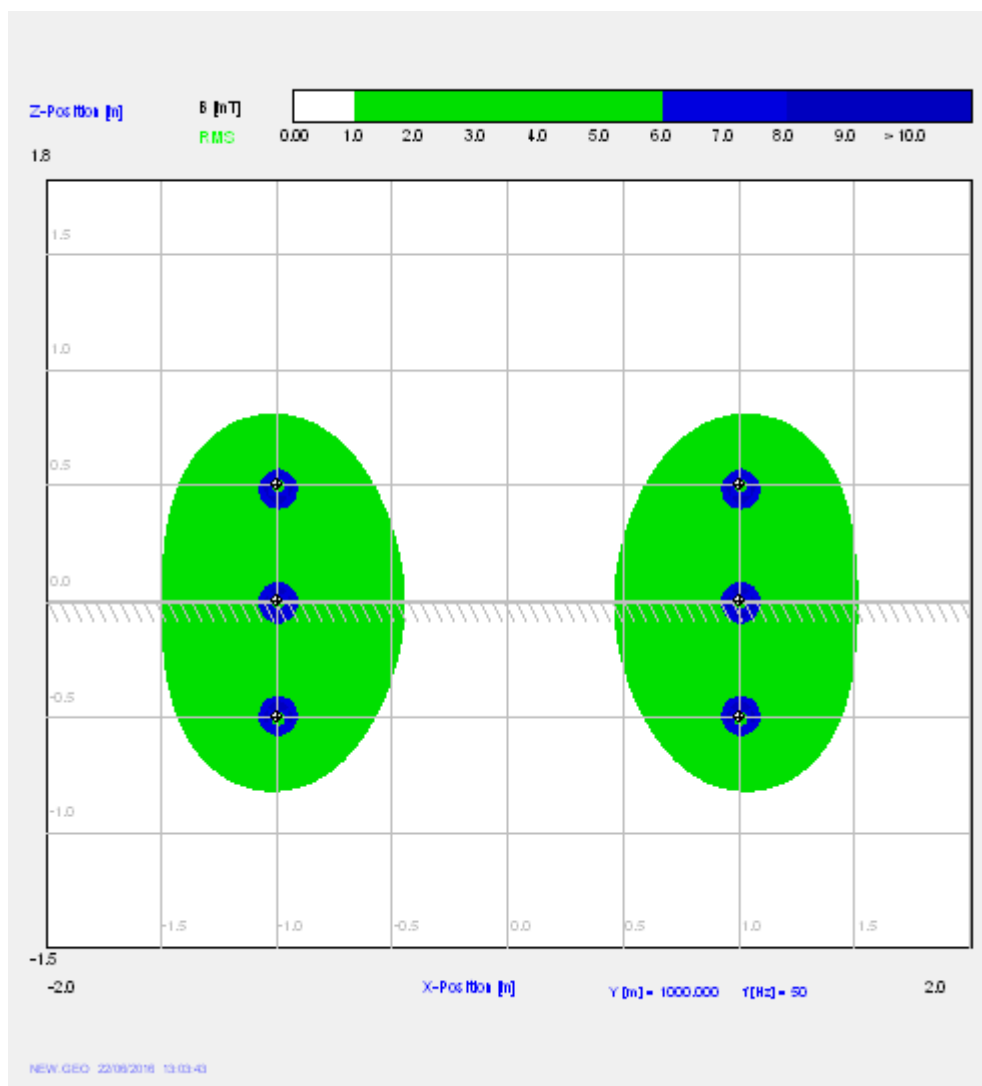

Close to one of the conductors, the field can be treated as a single conductor, considered in section 0.

3.16.3 Assessment of exposures

The Low Action Level is not exceeded if staff just walk down the central walkway of the tunnel, but is exceeded if they approach the cables.

For the High Action level, cable tunnels constitute a particular instance of close approach to a single current considered separately in section 0. The highest rating currently in use is 2400 A. For 2400 A, that assessment concluded that compliance is achieved if the cable outer diameter is greater than 140 mm, which is true for all known cables. That assessment was itself cautious because it considered a single conductor rather than a three-phase circuit.

Where there are multiple circuits in one tunnel, the maximum exposure is reduced, because it becomes less possible to be close to just one conductor without the cancelling effect of other conductors.

3.16.4 Control measures

This work triggers the procedures for identifying staff with AIMDs and pregnant staff.

No other controls are needed.

3.16.5 Triggers for reassessment

Cables of higher rating or smaller diameter that exceed the criteria established in section 0.

3.16.6 Assessment performed by

John Swanson, National Grid, 22/6/16. Based on calculations from first principles.

3.17 Distribution cable tunnels

3.17.1 Description of activity

The previous section considered transmission cable tunnels, up to 400 kV. This can be considered a limiting case, as these cables carry the highest currents; if they are compliant, then lower-voltage distribution cables, carrying lower currents, will also be compliant. However, for completeness, this section considers distribution cable tunnels.

Distribution cables are sometimes installed in underground tunnels. These can be dedicated circular bored tunnels extending some distance, similar to transmission tunnels, or they can be shorter tunnels underneath substations, of square cross section. Distribution cables can also be installed in shared-use tunnels with other utilities, which means that staff not working primarily on electrical systems and less familiar with the issues can be present in those tunnels.

Cables can be separate cores, usually bundled together, or they can be (more commonly at 11 kV) a single cable within an outer sheath.

3.17.2 Summary of exposures

Measurements were performed in the shared-use tunnel under Northumberland Avenue in London. This has multiple 11 kV combined-core cables, along with gas, telecommunications, and other utilities.

Along the central walkway of the tunnel the maximum field measured was 1.5 μT , with values usually less than 1 μT .

Against the surface of the various electric cables, the values measured were mostly 10-30 μT , occasionally 50 μT , with one cable in particular giving consistently 120-130 μT .

3.17.3 Assessment of exposures

The previous assessments of close approach to a single conductor and of transmission cables in tunnels demonstrate that distribution cables in tunnels are compliant.

The measurements performed reinforce this. The values measured are well below the High Action Level (and also the Low Action Level), by a sufficient margin that compliance would still be demonstrated allowing for higher loads than at the time of the measurements.

Where there are multiple circuits in one tunnel, the maximum exposure is reduced, because it becomes less possible to be close to just one conductor without the cancelling effect of other conductors.

3.17.4 Control measures

This work triggers the procedures for identifying staff with AIMDs and pregnant staff.

No other controls are needed.

3.17.5 Triggers for reassessment

None anticipated.

3.17.6 Assessment performed by

John Swanson, National Grid, 14/9/16. Based on measurements performed 2/8/16.

3.18 Live jointing

3.18.1 Description of activity

With 400 V underground cables, connections to new homes or other jointing work can be performed “live”, by excavating a trench, exposing and then pulling apart the outer sheath, and then pulling the cores apart sufficiently to strip the insulation and make joints.

3.18.2 Summary of exposures

A worst-case assessment can be made by treating the core being worked on as an isolated conductor. In practice, the other cores will reduce the field, meaning that compliance is actually less onerous than this assessment.

On the basis that the maximum current is 500 A:

- Field at 20 mm radius (approximation to hands): 5 mT
- Field at 200 mm radius (approximation to head or trunk): 0.5 mT

3.18.3 Assessment of exposures

On this worst-case assessment, the maximum fields for the limbs is 5 mT, which is less than the Limb Higher Action Level of 18 mT.

The maximum field for the head is 0.5 mT, which is less than the Low Action Level.

Therefore, live jointing is compliant.

3.18.4 Control measures

None needed.

This work triggers the procedures for identifying staff with AIMDs and pregnant staff.

3.18.5 Triggers for reassessment

None envisaged.

3.18.6 Assessment performed by

John Swanson, National Grid, 22/6/16. Based on assessment by ENA OSG SG11 2004.





3.19 Metering and associated activities

3.19.1 Description of activity

Electricity industry staff read meters or perform other work in the vicinity of meters, both in domestic premises but also in larger commercial premises where the meters may be of different design, of higher capacity, or where they may be multiple meters in close proximity.

Meters can be:

- a conventional rotating-disc meter
- an electronic but “dumb” meter
- a smart meter
- a bank of meters
- CT metering for larger loads

Typical rotating-disc meter	Smart meter	Individual CT meter used in commercial premises	Bank of CT meters
			

3.19.2 Summary of exposures

A typical rotating-disc meter produces a few tens of microteslas close to it, reducing to a microtesla or so at distances of tens of centimetres:

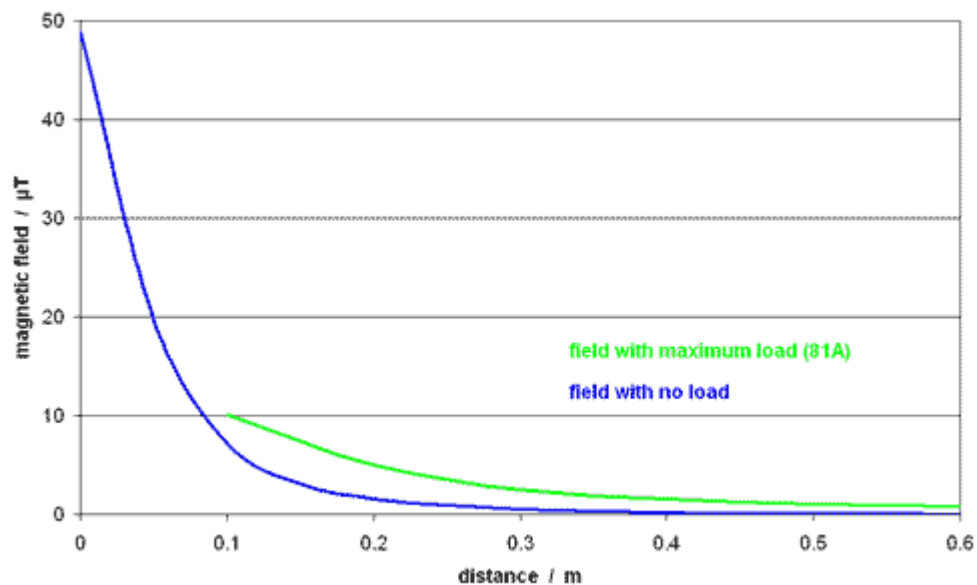

A bank of such meters produces at most just a small multiple of the field from an individual meter, because the fields from individual meters are confined to such a small volume.

Smart meters and electronic-but-dumb meters produce lower fields, because they do not contain the rotating disc and the coils to drive it, which are the main source of field in a rotating-disc meter.

CT meters, as would typically be used on larger commercial or industrial installations, typically produce 2-3 μT , maximum 5 μT , close to the surface. These meters are usually installed in a switchgear room, and there will typically be places in the same room where the distribution cabling produces higher fields than the meters themselves. For example, in instances where the meters themselves were measured at 5 μT or less, the cabling to the meters produced a maximum of 5 μT , various distribution panels 20-30 μT , and panels over transformers (on the LV side with the LV cable terminations close to the panel) 200-300 μT .

3.19.3 Assessment of exposures

Exposures received during metering operations are all compliant with the Low Action Level.

3.19.4 Control measures

None needed.

This work triggers the procedures for identifying staff with AIMDs and pregnant staff.

3.19.5 Triggers for reassessment

None envisaged.

3.19.6 Assessment performed by

John Swanson, National Grid, 23/11/16. Based on various measurements on various occasions including installations in commercial premises at Canary Wharf 10/8/16.

3.20 Fault switching

3.20.1 Description of activity

In the course of investigating and locating faults on 400 V and 11 kV networks, operators may need to re-energise a faulted circuit. Previously this was done by inserting a fuse; this practice is now discarded and either remote re-energisation device is used or the switching is done on the HV side. Under the previous regime, the operator could thereby be in close proximity to a large current for short periods of time. Under current practices, the operator would typically be no closer than 1 m to the energised and faulted circuit.

3.20.2 Summary of exposures

Two principal scenarios are identified:

- the fault current is effectively a single current, i.e. the location of the operator is close to the fault current but distant from the return path; or
- the fault current is largely balanced with the return path within the same cable, but forms a loop within switchgear or fuseboards etc at a substation where the operator is positioned.

These scenarios are defined by the geometry of the situation and apply equally to 11kV and to 400V operations.

Table 1 below gives the fault level that would be necessary to produce an electromagnetic field of 1 mT at the operator's body for the two scenarios:

Table 1. Calculated values of fault current for 1 mT field

Scenario	location of operator for 1 mT field	Current and Fault Level at 400V	Current and Fault Level at 11kV
Single fault current (distant return path)	Close to current (0.2 m, e.g. close to switchgear)	1 kA / 0.692 MVA	1 kA / 19. MVA
	farther from current (3 m, e.g. at bottom of pole)	15 kA / 10.4 MVA	15 kA / 286 MVA
Loop fault current (return path within switchgear; assumed dimensions of loop 0.5x1.5 m)	close to loop (0.2 m, e.g. close to switchgear)	1.56 kA / 1.08 MVA	1.56 kA / 29.8 MVA
	farther from current (1 m, e.g. at arm's length or using remote closer)	28.6 kA / 19.8 MVA	28.6 kA / 554 MVA

The currents corresponding to the High Action Levels are 6 times higher, and those corresponding to the health effects ELV perhaps 13 times higher.

3.20.3 Assessment of exposures

The fault currents for the two “close” locations are within the range encountered on distribution networks. This shows that switching onto faults can involve non-compliance, but whether non-compliance occurs for a given situation depends on the geometry of the fault current path, the location of the operator, and the fault current flowing. Non-compliance is most likely to occur where the operator is close (i.e. much less than one metre) to the current path, and less likely when they are more distant (i.e. one metre or more), as is the case for current work practices.

3.20.4 Control measures

Where faulted low voltage circuits are re-energised using a mechanical re-closing device the connecting leads should ideally be bundled in order to capitalize on the phase cancellation of the magnetic fields emanating from the different phases. Prior to re-closing the operator should be no closer to the connecting cables than is necessary for control of the re-closing device. For particular re-closing devices the following considerations apply:

FRED

It is not possible to bundle the cables due to the large electrical forces present when re-closing on to a faulted section of cable. Therefore the operators must rely on distance between themselves and the cables to minimize the risk of exposure.

REZAP

This device includes a countdown that should ensure that the operator has sufficient time to be able to stand clear at the time of re-closing.

3.20.5 Triggers for reassessment

None anticipated

3.20.6 Assessment performed by

John Swanson, National Grid, 22/6/16. Based on assessment by ENA OSG SG11 2004.

3.21 Mobile generators

3.21.1 Description of activity

Mobile diesel generators are used to maintain supply to homes when the supply has to be disconnected. These are typically lorry-mounted and connected to the relevant substation by flexible cables laid across the intervening ground.

3.21.2 Summary of exposures

Tests were carried out to identify the field strength around the cables from a 455 kVA mobile generator supplying a 600 kW three phase load-bank with an additional 30 kW single-phase loadbank, the latter was in circuit to produce out of balance load conditions. The cables were 70 mm non-screened single core cables, 10 m in length.

Readings were taken, direct on the cable and at the following distances above the cables: 100 mm, 200 mm, 500 mm & 1000 mm. Measurements were taken with the cables laid out randomly and then with the cables laid in trefoil formation.

The table lists the measurements taken with the generator and cables loaded between 450 A and 520 A and with the out of balance load bank in circuit.

Distance from cables	EMF values measured (μT)	
	Cables laid random	Cables bundled in trefoil
Directly onto the cable	563	410
100 mm	464	263
200 mm	382	96
500 mm	123	22
1 m	31	6

Note: Measurements around the generator ranged from 2 μT to 12 μT .

3.21.3 Assessment of exposures

If a reasonable distance for the operator's body to approach the cables is taken as 200 mm, fields are compliant with the lower action level at currents up to 5 kA, more than is ever used in practice.

3.21.4 Control measures

Cables should be bundled as a matter of good practice, but no measures are actually required.

This work theoretically triggers the provisions for staff with AIMDs and pregnant staff. However, the zone where fields sufficient even theoretically to cause interference with an

AIMD are limited to less than 200 mm of the cables (if bundled in trefoil) and it is considered that in practice the risk is negligible.

3.21.5 Triggers for reassessment

None anticipated

3.21.6 Assessment performed by

John Swanson, National Grid, 22/6/16. Based on assessment by ENA OSG SG11 2004.

3.22 Welding activities

3.22.1 Description of activity

Welding is an activity that is performed in the electricity industry as an adjunct to the core business; correspondingly, there is a whole industry for which welding is a core activity. Accordingly, the electricity industry does not assess EMF compliance from welding from first principles itself, but relies on assessments available from the welding industry.

Specifically, the source document for initial assessments of compliance is an HSE/TWI Research Report¹².

This Report includes a comprehensive literature review and results of measurements performed on:

- Pulsed MIG/MAG welding.
- AC square wave TIG welding.
- Single-phase AC resistance welding.
- Medium frequency resistance welding.
- Magnetic particle inspection (MPI).
- Stud welding.
- Induction heating.

3.22.2 Summary of exposures

The conclusions, summarised, are:

For arc welding processes operating in DC mode the low ALs were not exceeded even in situations where the workers were in very close proximity to the magnetic field.

However, for AC and pulsed arc processes higher magnetic fields were measured. Although the limb AL was not exceeded for hand held torches, close to a bent welding cable the field to which the welder may be exposed, was found to approach the low AL. It is unlikely that the High AL would be exceeded.

Due to the much higher welding current used for resistance welding processes, the fields to which welders may be exposed were found to be much higher than for arc processes and exposure is very dependent on welder position. For equipment operating at mains frequency, it is possible the low AL could be exceeded, but it is unlikely that the High AL would be exceeded.

In resistance welding, if the welder is holding components close to the electrodes, hand exposure may exceed the limb AL depending on welding parameters.

¹² Research Report RR1018 "Electromagnetic Fields (EMF) in the welding environment" prepared by TWI Ltd [formerly The Welding Institute] for the Health and Safety Executive 2014

For medium frequency equipment (typically 2kHz), the magnetic field at positions up to 500mm from the electrodes is likely to exceed the low AL when using typical operating parameters. Closer to the electrodes, the high AL and limb AL are also likely to be exceeded. However, this equipment would typically be robot-operated and is unlikely to be used in the electricity industry.

There are many variants of the stud welding process, but for the capacitive discharge variant tested, the field was found to exceed the low AL at positions normally occupied by the welder, but not by such a margin as to suggest that the High AL or Health ELV would be exceeded.

Magnetic particle Inspection (MPI) is a widely used technique for detecting cracks in welds. For standard equipment, the external magnetic field was found to be low, but techniques for inspecting large components may result in the inspector being exposed to fields above the low AL. These techniques are unlikely to be used in the electricity industry.

Induction heating is used for brazing and pre-heating components before welding. Typically, for brazing the field was found to be below the low AL, but for pre-heating large components the ALs may be exceeded. These techniques are unlikely to be used in the electricity industry.

3.22.3 Assessment of exposures

It is very unlikely that any welding activities undertaken within the electricity industry are such as to produce exposures exceeding the High AL or the Health ELV.

If specific welding activities give rise to concern, they should be assessed on a case-by-case basis.

3.22.4 Control measures

It is good practice not to arrange the “go” and “return” cable either side of the body, and not to hold small components manually close to the welding electrodes.

3.22.5 Triggers for reassessment

Any welding activities not covered by the HSE Report should be assessed on a case-by-case basis.

3.22.6 Assessment performed by

John Swanson, National Grid, 22/6/16. Based on HSE/TWO Report as referenced.

3.23 Cellular Antennas

3.23.1 Description of activity

Cellular antennas can be located on or near electricity infrastructure. These are often installed and maintained by 3rd parties who have their own risk assessments and procedures for safe access. There are occasions where electricity staff have to work on electricity infrastructure with such antennas, and therefore the issue of exposure needs to be considered.

Cellular equipment produces radiofrequency fields (RF) typically in the frequency ranges of 450 MHz and above. The Regulations specify Exposure Limits values in terms of the Specific Absorption rate (SAR) at these frequencies.

3.23.2 Summary of exposures

Due to the physical structures (i.e. towers) cellular antennae are mounted on in the electricity industry, they are on the whole directional, although omnidirectional antennae are available. The RF produced is therefore directional and the intensity of radiation falls off rapidly with distance. The strength of the RF will depend on the power output of the antenna and whether multi antennae are present and the RF zones overlap.

As the RF fields reduce with distance from the antenna, it is possible to define an area close to the antenna where the Occupational Action Level will be exceeded and outside of which it will not. The area of RF exposure exceeding the Action Level can be defined as follows:

Side view

Plan view

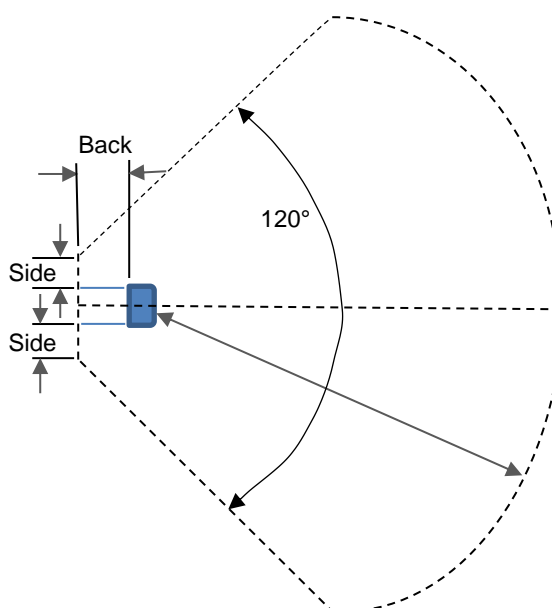
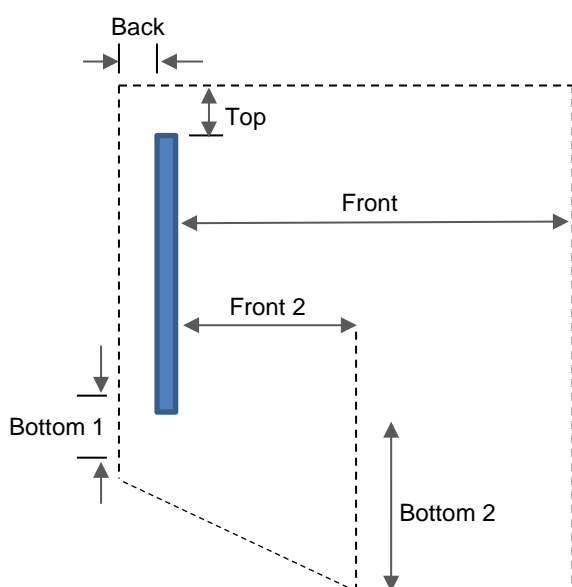

3.23.3 Assessment of exposures

Areas where the occupational AL and the public exposure limits could be exceeded have been defined by Arqiva using the maximum power output of cellular antenna (evidence supplied in Company Report BOS125_2)

	Front	Front 2	Back	Side	Top	Bottom 1	Bottom 2
Public exposure limit	22m	12m	0.2m	0.2m	1.0m	1.0m	3.3m
Occupational ALs	10m	4.7m	0.1m	0.1m	0.2m	0.2m	1.4m

Access to areas exceeding the Occupational ALs should be restricted by appropriate access procedures.

3.23.4 Control measures

This work triggers the procedures for identifying staff with AIMDs and pregnant staff.

3.23.5 Triggers for reassessment

New cellular antennae using higher power levels than those assessed in Arqiva BOS125_2.

3.24 Telecommunications equipment (Portable)

3.24.1 Description of activity

Electricity industry staff use a variety of hand-held or vehicle-mounted personal mobile radio (PMR) equipment.

Telecommunications equipment produces radiofrequency fields. The Regulations specify Exposure Limits values in terms of the Specific Absorption rate, SAR.

“Mobile phones and two-way radios” are “activities not requiring further assessment” as listed in the EU Practical Guide and the HSE Guidance, detailed above.

3.24.2 Summary of exposures

Various assessments have been performed by outside agencies and are publicly available.

In particular, in relation to one system, TETRA, widely used by emergency services and also by some electricity companies:

“Police Information Technology Tender CS 799: Specific Absorption Rate Measurements in Vehicles. Final Report. Dr Philip Chadwick, Technical Director, MCL. 2006”

This examines the use of TETRA radios, both personal (measured in the context of use while in a building) and vehicle-mounted. It found

- The maximum 10 g-average localised SARs from the 1 W TETRA personal radios tested, determined by computation or measurement, were approximately 0.5 W/kg. The corresponding Exposure Limit Value for these frequencies is 10 W/kg (10 g tissue average in head and trunk).
- The maximum whole-body average SARs were below 0.004 W/kg. The Exposure Limit Value for these frequencies is 0.4 W/kg (whole body average).

3.24.3 Assessment of exposures

The EU Practical Guide and the HSE Guidance both indicate that “two-way radios” can be assumed to comply without further investigation. There could be ambiguity in what counts as a “two-way radio”, as opposed to something more specialised. However, the available measurements, on TETRA, indicate that compliance is by a factor of 20. This is a sufficient margin to give confidence that other systems, different in detail but broadly similar in terms of power levels, would also be compliant.

3.24.4 Control measures

None needed.

3.24.5 Triggers for reassessment

Power levels significantly higher than those applicable to TETRA (TETRA operates at 1 W for personal devices and 3 W for vehicle-mounted devices).

As further assessments for specific systems become available, they should be included in this section.

3.24.6 Assessment performed by

John Swanson, National Grid, 20/4/17.

3.25 Satellite equipment (above 6 GHz)

3.25.1 Description of activity

Satellite dishes may be used on electricity sites or offices for telemetry data. These are often installed and maintained by 3rd parties who have their own risk assessments and procedures for safe access. However, electricity staff may need access to areas where satellites are installed, such as roof spaces.

Satellite equipment produces radiofrequency fields (RF) typically in the frequency range 10-18 GHz. At very high frequencies (above 6 GHz) where the depth of penetration within the body is low both ELVs and ALs are presented in terms of power density and have the same numerical value. At these frequencies, the ELVs and ALs limit the radiated power occurring on the body surface. The Occupational Action Level which apply to satellite antenna is 50W/m², and the Public Action level is 10W/m².

3.25.2 Summary of exposures

Satellite-earth station antennas are directed toward satellites above the earth and the transmitted beam point skyward at various angles of inclination, depending on the particular satellite being used.

The radiofrequency (RF) signals used for transmitting earth-to-satellite signals are concentrated and highly directional, similar to the beam from a flashlight. The greatest RF signal strengths are directly in front of a transmitting satellite antenna, that is, within the beam. There is very little RF signal outside the beam being transmitted from the antenna. The RF produced by the satellite is a function of the amplifier power and dish size.

3.25.3 Assessment of exposures

In general, satellites with an elevation of greater than 10° are mostly compliant with the Occupational AL 1m from the antenna.

However, each satellite dish installation should be assessed by the installation company determining minimum distances to comply with both the public and occupational ALs

3.25.4 Control measures

Access to directly in front of the transmitting antenna should be restricted by physical barriers and/ or access procedures, restricting exposures above Occupational ALs.

Active Implanted Medical Devices are governed by general requirements from the Active Implantable Medical Devices Directive¹³ and the Medical Devices Regulations 2002.

¹³ 90/385/EEC first established in 1990 with subsequent amendments

At frequencies of 10 kHz and above these regulations require AIMDs to be immune to 141 V/m and below. This equates to a power density of 52.4 W/m² which is very close to the Occupational AL.

This work triggers the procedures for identifying staff with AIMDs and pregnant staff.

3.25.5 Triggers for reassessment

For new installations, manufacturers should provide data on distances to comply with Occupational & Public ALs.

Restrictions such as barriers or access procedures must be applied to areas exceeding the Occupational AL.

3.25.6 Assessment performed by

Hayley Tripp, National Grid, 01/11/2018. Calculations provided Vodafone 03/10/2018

3.26 Satellite equipment Annex- Specific equipment

3.26.1 Eutelsat E10A Satellite

Located at National Grid House, Warwick.

Maximum amplifier power of 25 W, 3.7 m antenna and installed with an elevation angle of 30deg. The satellite operates at 14 GHz.

Calculations provided by Vodafone

Amplifier Power	25	W	Min distance to comply with Public ALs, m	Min distance to comply with Occupational ALs, m
Dish size	3.7	m		
Gain at 14 GHz, Main beam	52.7	dBi	192.47	86.06
Gain to horizon at 10° elevation	4	dBi	0.71	0.32
Gain to horizon at 20° elevation	-3.53	dBi	0.30	0.13
Gain >45° from main beam	-10	dBi	0.14	0.06

Based on Public AL for RF, 10W/m² and Occupational AL, 50W/m²

Compliance will be achieved if personnel are restricted from approaching the back or sides of the antenna closer than 0.06m and closer to the edge of the main beam than 0.32m.

3.27 Fault currents and transients

3.27.1 Description of activity

Normal operation of transmission and distribution systems involves various ways in which voltages or currents higher than normal are produced, but lasting only very short periods, typically only a few cycles of the 50 Hz waveform. Examples are faults; switching transients; lightning strikes; and inrush currents.

3.27.2 Summary of exposures

Faults

Overview

Faults are unwanted events that occur on the electricity system from time to time. They are rare because of the many preventative measures that are taken, but they are inherent in the operation of an electricity system and cannot be avoided altogether. Faults have a variety of causes, including plant failure at power stations or on the transmission system, and weather-related events. Lightning is the most common cause.

All faults occurring on an electrical transmission system are recorded and their causes are investigated as appropriate. An order of magnitude is that there are approximately 10 faults per year for 1000 km of transmission system.

Short-circuit currents during faults

The main characteristic of a fault is a short-duration increase in the current in one or more of the phases. The voltage can also be affected but to a much lesser extent. The current that flows depends on the circumstances surrounding the fault. The highest current at any given point on the system is expressed as the "fault level", which varies throughout the system and depends on the system impedances between the location of the fault and the sources of the power. The highest fault level found on present-day transmission systems is typically around 60 kA (taking into account all the possible network system voltages), corresponding to the rating of the switchgear, which has to be able to break the highest fault current.

Prevention and protection against faults

Faults are undesirable from an operational point of view because they disrupt the electricity supply and can cause damage to connected equipment. Considerable efforts are devoted towards preventing faults from occurring. Maintenance and replacement strategies, and the provision of earth wires on overhead lines, are designed to prevent them occurring in the first place, and "protection systems" are in place throughout the network to ensure faults are detected and isolated as soon as is technologically feasible after they have occurred.

The target fault clearance time (for the main in-feeding circuit) is specified as 80 ms to 120 ms for systems at 400 kV to 66 kV, i.e. at most two or three cycles of a 50 Hz wave. Slightly longer values may apply when the fault is also being fed from a remote end, but in that instance, the fault current is also lower. Once the fault has been cleared, the circuit can be switched back on, and the current, and the resulting exposures, will revert to normal levels. On the lowest-voltage distribution systems where fuses are used, low-level faults may be sustained for longer than a second, but the current and therefore exposures would be correspondingly lower as well.

Magnetic field exposures during faults

In practice, faults do not in fact normally result in exposures exceeding the ELV.

The highest fault level anywhere on a high-voltage transmission system is around 60 kA. Fault levels on lower-voltage systems tend to be lower than this. The highest magnetic-field exposure to someone standing on the ground close to an overhead line will result if a fault current flows in the bottom conductor. The lowest permissible ground clearance for 400 kV circuits varies from country to country and with other factors such as the use of the land being crossed, but is typically no less than 8 m. In practice the ground clearance is usually greater than this. At 1 m above the ground, i.e. 7 m from a minimum-height conductor carrying 60 kA, the field would be 1,700 μT , less than the High Action Level. In other words this worst-case fault situation would still be compliant with the Directive. Furthermore normally the line will be at a greater height, the fault may not be on the bottom phase, the current may be lower than the fault level, and, the probability of someone being in that location when the fault occurs (usually during a thunder storm) is minimal.

Potential problems would therefore occur only for situations where workers are closer to the conductor than on the ground beneath an overhead line, such as when working on transmission towers, in substations, in cable tunnels or in the vicinity of underground three-phase cables. The probability of a worker being in one of these locations at the instant of a fault is low.

In some circumstances, it is permissible to operate a circuit permanently under fault conditions, but this occurs only when the fault current is within the rating of the circuit, and therefore does not give rise to any higher exposures than normal operations.

Switching transients

When switching the voltage on to an overhead-line circuit, the complex electrical parameters of the overhead line give rise to transient voltages. For transmission circuits, these comprise a waveform at a higher frequency, typically of order 1 kHz, superimposed on the 50 Hz waveform, and lasting typically no more than one cycle of the 50 Hz, 20 ms. The initial amplitude of the higher frequency can be comparable to the amplitude of the 50 Hz, meaning that the peak voltage can be roughly doubled. (If, at the instant it is re-energised, the line still has charge on it from a previous energisation, higher peak voltages, up to typically three times the steady-state peak voltage, can be produced; it is to avoid this that transmission systems are usually operated with a delay before re-energisation, to allow the

trapped charge to leak away. This transient voltage would give rise to a transient electric-field exposure to a worker located on a tower at the relevant place at the instant the voltage was applied.

Lightning strikes

As already stated, lightning strikes are one of the more common causes of faults on transmission systems, and therefore are the indirect cause of the high currents that flow during a fault. However, the lightning strike also increases the voltage of the circuit for the short duration it lasts for. The maximum voltage is determined by the insulation properties of the circuit (when the voltage produced by the lightning strike exceeds the insulation withstand voltage, the voltage flashes over, which is the cause of the fault). This limits the peak voltage to, typically, three times the peak voltage under steady-state conditions. The duration of this transient voltage is usually taken as less than 1 ms.

Inrush currents

Some loads that are connected to distribution systems, such as motors, produce an inrush current when first energised. This can be larger than the steady state current by a factor up to 32 but lasts typically half a cycle, 10 ms.

3.27.3 Assessment of exposures

In all these cases, the duration of any high exposures is strictly limited. In the case of faults, this is ensured by the protection systems that disconnect a faulted circuit. In the case of switching transients and inrush currents, it is ensured by the intrinsic characteristics of electrical circuits. This therefore fulfils one of the requirements of Article 5(8): that immediate action should be taken to remove exposure in excess of the limits.

The probability of over-exposure actually occurring is extremely small, because it necessitates a worker to be present in a specific location (on the body of a tower with live circuits level with the conductors; close to the path of the fault current) at the instant that an already rare event (switching or fault) occurs.

If, however, this extremely low-probability exposure event does take place, the duration of the exposure is at most a few cycles of the 50 Hz waveform. Such short exposures are unlikely to have significant biological effects. Neither the Directive, nor the ICNIRP exposure guidelines on which it is based, give quantified guidance as to the relevant duration of exposure. In the absence of specific guidance from ICNIRP, it is legitimate to draw on the corresponding IEEE standard¹⁴. This states that the averaging time for assessing exposures is 200 ms or ten cycles of 50 Hz (specified in 5.2.1 and 5.3.1; justification in 6.1.4). All the transient exposures discussed here are of less duration than this (or, if they are of longer duration, e.g. some faults on low-voltage distribution systems or, on

¹⁴ IEEE C95.6 (2002)

transmission systems, faults that take longer to clear because they are remote from the protection, they are of lower level).

Therefore, these transient exposures are extremely unlikely to constitute over-exposure, and no further action need be taken.

Where controlled fault currents are applied intentionally, for example for testing or for fault location, then planned protective measures may nonetheless need to be taken to ensure exposures remain lower than the ELVs.

3.27.4 Control measures

None needed.

3.27.5 Triggers for reassessment

Increases in fault levels greater than 60kA

3.27.6 Assessment performed by

John Swanson, National Grid, 22/6/16. Based on draft CENELEC Standard..

3.28 HVDC convertor stations

3.28.1 Description of activity

HVDC convertor stations convert between AC and DC. ENA member companies operate the following:

Currently operating:

- Sellindge (IFA1)
- Grain (BritNed)
- Richborough (Nemo Link)
- Caithness-Moray link (SSEN)

Planned or under consideration:

- Hunterston and Deeside (Western Link)
- Daedalus (IFA2)

There are other interconnectors with HVDC convertor stations, e.g. to Ireland, that do not fall within the scope of this Risk Assessment.

The convertor stations typically comprise:

- Valve halls – not accessed when the equipment is live so not assessed further
- DC Halls containing switching, metering etc – accessed when the equipment is live
- Associated AC substations
- Extra filters and possibly reactive compensation

Of these, the AC substations are covered by the relevant section of this Risk Assessment. Likewise, the filters and, at Sellindge, the reactive compensation, are covered by the section of this Risk Assessment dealing with air-cored reactors. This assessment therefore covers the DC Halls.

3.28.2 Summary of exposures

The following table presents data from Sellindge and Grain. It is assumed that other HVDC Convertor Stations will be similar, but they can be assessed as necessary. Areas of restricted access are present within HVDC convertor stations, mainly the valve hall when live. Where live access is restricted, these areas have not been included in the risk assessment.

	Selindge	Grain
AC electric fields	Negligible due to absence of exposed HVAC equipment	
AC magnetic fields	Maximum 30 μ T against wall to valve hall Typical 1-4 μ T	Maximum: 6 μ T (with strong harmonic content) against fence around reactor

DC electric fields	Not assessed; expected to be similar to Grain	Maximum: +18 kV/m and - 21 kV/m Typical values: 5-10 kV/m
DC magnetic fields	Maximum at closest approach to bipole cables: 4000 μT^* Typical: 60-200 μT	Maximum at closest approach to bipole cables: 1400 μT^* Maximum at closest approach to reactor (against fence): 700 μT Typical: 70-200 μT

* Note: differing values are partly attributable to the different size probes used as the field is critically dependent on the closest approach to the cable.

3.28.3 Assessment of exposures

AC fields are below the Low Action levels.

For DC fields, the equivalent limits are 2T for magnetic fields. There is no DC electric field limit but a guideline figure of 25 kV/m is used. DC fields are below these limits.

3.28.4 Control measures

No control measures necessary.

This work triggers the procedures for identifying staff with AIMDs and pregnant staff.

3.28.5 Triggers for reassessment

Future HVDC Converter Stations should be assessed either by the supplier or on a case-by-case basis by the TSO.

3.28.6 Assessment performed by

John Swanson, National Grid, 22/6/16. Based on measurements on various occasions from 1990s to 2016.

3.29 HVDC cables

3.29.1 Description of activity

HVDC cables are typically direct buried, but may sometimes be placed in tunnels. The currents are, clearly, usually DC, but in fault conditions, an AC component can be present.

3.29.2 Summary of exposures

Cables in tunnels always produce higher exposures (because they can be approached closer) than direct buried cables, so tunnels constitute the limiting case for assessment of compliance.

DC current ratings of DC cables are comparable to the AC current ratings of AC cables, and therefore the DC produce a similar field level (but DC) to AC cables, as treated in section 3.16.

AC currents in DC cables under fault conditions have been obtained for one specific instance, a commutator failure on IFA1:

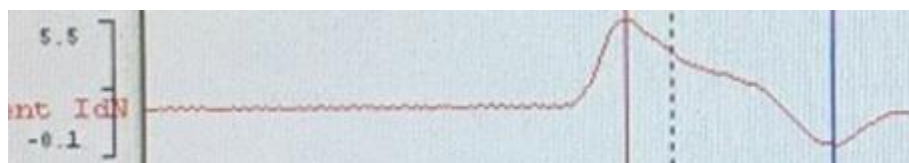

The scale is in kA and this fault current is split between two conductors. The interval between the red and blue vertical lines is 33 ms.

3.29.3 Assessment of exposures

For DC fields, the equivalent limits are 2T for magnetic fields. As the AC exposures in cable tunnels are compliant with the AC High Action level of 6 mT, the DC exposures are compliant with the relevant limit by a large margin.

Short duration events such as faults and switching transients are covered under section 3.27, which established an averaging time of 10 cycles of 50 Hz or 200 ms for biological effects to become potentially relevant. No fault condition of an HVDC cable would last this long, so exposures during any faults are not biologically relevant and do not come under the scope of the Regulations.

However, even if they were regarded as relevant, simple analysis shows that they would still be compliant.

If the AC current waveform under fault conditions is approximated as a single cycle of a sine wave, the amplitude (allowing for two conductors and converting to rms) and frequency (actually 30 Hz in this instance) are comparable to the parameters for AC cables. AC cables

are assessed as compliant in section 3.16, using a simplified methodology that provides a very conservative assessment. Further, the treatment of the current as a sine wave is also conservative. Therefore, even allowing for possible fault events that are more extreme than the one assessed, exposures under these circumstances are also assessed as compliant.

3.29.4 Control measures

No control measures necessary.

This work triggers the procedures for identifying staff with AIMDs and pregnant staff.

3.29.5 Triggers for reassessment

HVDC installations with electrical characteristics capable of producing significantly higher di/dt .

3.29.6 Assessment performed by

John Swanson, National Grid, 4/6/18. Transient recording provided by Ian Plowright.

3.30 Operation of Generators – Routine Generation

3.30.1 Description of activity

Generators are normally installed in a generator hall and typically have an access walkway that extends around the non-drive end and along the sides of the generator. In addition, there may be some access beneath the generator.

In order to generate the static magnetic field required for power generation, each generator has an excitation system. Power for the excitation system normally comes either from the main stator output (self-excited) or from a small self-excited or permanent magnet generator located at the non-drive end of the generator. Excitation current is rectified and fed into the generator rotor, normally via a brush and slip-ring arrangement at the non-drive end of the generator. Excitation current is controlled by the automatic voltage regulator (AVR) in order to maintain a constant voltage output from the generator.

The output from the generator is fed into an isolated phase bus (see *Power Distribution*) via the generator terminals. Generator terminals are generally at either the top or bottom of the generator and each connects to a separate phase winding in the stator. The other ends of the phase windings are normally connected at the star point, which is indirectly connected to earth, via a transformer, reactor or resistor.

3.30.2 Summary of exposures

Electric fields

There are no exposed high voltage conductors in the area around the generator and consequently no expectation of strong electric fields.

Magnetic fields

Strong magnetic fields are generated in the vicinity of the stator and exciter brush gear. These fields should not exceed the low action levels at any normally accessible position although they are likely to exceed the Council Recommendation reference levels close to the generator. In some cases magnetic flux densities exceed the reference levels by a considerable margin and remain above the reference levels across the entire width of the access walkway around the generator.

Strong magnetic fields are also generated around the excitation systems. Rectification of the exciter current generates components at high frequencies where the action and reference levels are more restrictive. In one case magnetic flux densities exceed both the low and high action levels to distances of up to 0.4 m from cables running down the outside of the transformer enclosure. Any similar situation is likely to produce the same result. In all cases magnetic flux densities exceed the Council Recommendation reference levels by a considerable margin.

Strong magnetic fields may be generated in the vicinity of the generator main terminals, although these are not normally accessible during normal running. Where access is possible, for example when terminals are located beneath the generator, magnetic flux

densities should not exceed the low action levels, but will exceed the Council Recommendation reference levels by a considerable margin. In one case strong fields were also measured in the vicinity of the generator neutral point, where exposure at the high action levels was possible.

3.30.3 Assessment of exposures

Electric fields

There are no unscreened high voltage conductors in these areas and consequently no source for strong electric fields. There is no requirement to make any further assessment of exposures in these situations.

Magnetic fields

Accessible magnetic fields measured around the stator end of the generator were typically around 150 – 200 % of the reference levels. Fields were lower around exciter brush gear, typically around the reference levels, although the highest value measured was 190 % of the reference levels.

Strong fields were measured in the vicinity of rectifiers, transformers, and automatic voltage regulators associated with generator excitation systems. The strongest field was measured around cables running down the outside of an exciter transformer enclosure and represented 150 % of the high action levels. The region over which the high action levels were exceeded extended for 0.35 m from the cables and was therefore just large enough to get a body into. Magnetic flux densities at the surface of the cable also exceeded the limb action levels. Fields around other excitation equipment did not exceed the action levels, but were generally well in excess of the reference levels, with the maximum measured field representing 700 %. Fields in excess of the reference levels extended across access walkways around the equipment.

At Staythorpe an isolated phase bus was used to take the neutral ends of the stator windings to the generator neutral point beneath the generator. Strong fields measured in the vicinity of this installation were around 100 % of the low and high action levels. At Aberthaw the generator terminals connected to the isolated phase bus in an interlocked enclosure beneath the generator. Magnetic flux densities at the door represented 450 % of the reference levels and remained above the reference levels to the top of the access stairs, approximately 2 m from the door.

3.30.4 Control measures

For any area close to an exciter transformer where the high action levels are exceeded, access must be restricted whilst the excitation system is operational. Given that this is likely to affect only a small area, this could be achieved either by extending the transformer enclosure, or by means of suitable floor markings.

For any area around the generator neutral point where exposure at the high action levels is possible, access must be restricted whilst the generator is in operation. In the example

where this was observed, the area was already demarcated by means of physical barriers and gates (Figure 1) so that access restriction should be straightforward to achieve.



Figure 1 Area around the generator neutral point at Staythorpe Power Station where strong fields were measured

In the absence of a person-specific individual assessment, workers at particular risk should be excluded from access to generators, generator terminals, isolated phase bus systems and all parts of generator excitation systems whenever this equipment is operational.

3.30.5 Triggers for reassessment

Any new or modified designs for excitation systems.

3.30.6 Assessment performed by

Public Health England under contract to Energy UK. Inserted in this risk assessment by John Swanson 29/6/16.

3.31 Operation of Generators – Infrequent Activities

3.31.1 Description of activity

This section considers two activities that are undertaken routinely, but infrequently: start-up and live changing of exciter brushes.

During start-up, power is fed into the generator so that it is temporarily used as a motor to drive the turbine. When the turbine reaches operating speed, it is fired and the generator reverts to generation. As the generator has to accelerate from barring speed to full operational speed, a static frequency converter is used to change the frequency of the drive current. This uses thyristors to achieve the frequency shift and in doing so it generates field components at high frequency where the action and reference levels are more restrictive. It is understood that the load on the static frequency converter is highest during the initial phase of start-up and tails off as the generator reaches full operational speed.

The brushes on the excitation systems wear and require periodic replacement. This may be undertaken live so that there is no requirement to stop the generator. This activity will involve work in close proximity to the exciter conductors and in particular limb exposure essentially in contact with the conductors.

3.31.2 Summary of exposures

Electric fields

There are no exposed high voltage conductors in the areas around either the static frequency converter or exciter brushes and consequently no expectation of strong electric fields.

Magnetic fields

During turbine start-up the static frequency converter cabinets generate strong magnetic fields with a wide range of frequency components. The low action levels will not be exceeded, but the Council Recommendation reference levels are exceeded up to 0.6 m from the surface of the cabinets.

Accessible fields around the exciter brushes do not exceed the low action levels and magnetic flux densities in contact with the exciter cables do not exceed the limb action levels implying that limb exposures will be compliant during live brush changes. Fields around the exciter cables exceed the Council Recommendation reference levels by a considerable margin.

3.31.3 Assessment of exposures

Electric fields

There are no unscreened high voltage conductors in these areas and consequently no source for strong electric fields. There is no requirement to make any further assessment of exposures in these situations.

Magnetic fields

Strong magnetic fields are generated in the vicinity of the static frequency converter cabinet during generator start-up and prior to firing the gas turbine. It is understood that the highest currents are provided during initial acceleration of the generator and so measurement results from a single start may not give an accurate indication of the spatial distribution of the fields. The measured fields did not exceed the low action levels, but did represent 570 % of the Council Recommendation reference levels. Magnetic flux densities exceeded the reference levels up to 0.6 m from the surfaces of the cabinets. Spectral analysis of the fields indicated the presence of multiple frequency components.

It was not possible to directly assess exposures during a live brush change on the generator exciter, so exposures were assessed by assessing whole body exposures around the brush gear enclosure and limb exposures in contact with the exciter cables. Exposures outside the exciter brush gear enclosures, which is where whole body exposure would occur, were generally around 15 – 20 % of the low action levels. Exposures in contact with the exciter cables, which approximate to the position of the hands during a live brush change, represented 1.4 % of the limb action levels. As noted above, magnetic flux densities around the exciter brush gear are generally around the reference levels and in the worst case was 190 %.

3.31.4 Control measures

In the absence of a person-specific individual assessment, workers at particular risk should be excluded from access to all parts of generator excitation systems whenever it is operational and to the area around the static frequency converter during start-up.

3.31.5 Triggers for reassessment

Any significant change to the design of static frequency converters or generator excitation systems.

3.31.6 Assessment performed by

Public Health England under contract to Energy UK. Inserted in this risk assessment by John Swanson 29/6/16.

3.32 Power Distribution

3.32.1 Description of activity

The generator terminals normally feed power into an isolated phase bus. For each phase this consists of a hollow conductor of circular, octagonal, or hexagonal cross-section housed centrally within a non-magnetic metallic enclosure that is grounded. The flow of current through the conductor induces an opposing current flow in the enclosure that normally results in significant cancellation of magnetic fields.

The isolated phase bus delivers power to the generator transformer, which steps up the voltage from the generator voltage (normally around 15 – 25 kV) to the grid voltage (normally 275 or 400 kV). The output phases from the generator transformer normally pass to a banking compound or National Grid substation via overhead uninsulated bus bars, overhead uninsulated lines, or underground insulated cables, or a combination of the above.

There are normally tee junctions on the isolated phase bus to tap power off to the unit auxiliary transformer. This transformer provides power to run the unit and is normally tapped to provide 11 kV and 6.6 kV outputs, although for some stations the latter may be replaced with a 3.3 kV tap. The output from this transformer is distributed via high voltage switchgear in dedicated switch rooms and will be used to feed transformers stepping down to 415 V. The output from these transformers is distributed via low voltage switchgear.

The transformers are cooled using a variety of approaches, including integral cooling fans of various sizes, separate cooling units incorporating integral cooling fans and separate cooling units utilising cooling water.

3.32.2 Summary of exposures

Electric fields

There are overhead exposed bus bars and lines maintained at high potential and it would therefore be expected that there will be strong electric fields. These fields do not exceed the low action levels, although in some cases may exceed the Council Recommendation reference levels.

Magnetic fields

Magnetic fields in the vicinity of the isolated phase bus, where this is accessible, are below the low action levels, but in some cases may exceed the Council Recommendation reference levels by a considerable margin.

Magnetic fields around the generator and unit auxiliary transformers are below the low action levels, but in some cases exceed the Council Recommendation reference levels in localised areas, particularly in the vicinity of output cables from the latter. In addition, strong fields are often accessible in the vicinity of earth conductors and whilst these do not exceed the low action levels, they sometimes exceed the reference levels by a considerable margin.

Strong magnetic fields are generated in high voltage (11 kV) switch rooms. This is to be expected as the cables from the unit auxiliary transformers (carrying 100's of amperes) enter these switch rooms. Magnetic flux densities may exceed the low action levels, but only over a region that is too localised to give rise to a whole body exposure. The reference levels may be exceeded in these switch rooms. In addition, in one case an earth conductor from a high voltage switch room, but running outside it, was carrying sufficient current to generate a magnetic flux density that exceeded the reference levels.

Accessible magnetic flux densities in medium voltage (6.6 kV) and low voltage (415 V) switch rooms were below both the action levels and the reference levels.

Magnetic flux densities outside banking compounds and National Grid substations do not exceed action levels or reference levels.

3.32.3 Assessment of exposures

Electric fields

There are exposed high voltage conductors associated with generator transformer compounds and transmission of power to banking compounds and National Grid substations. These will result in the generation of strong electric fields. Nevertheless, the presence of earthed metal fencing around transformer and banking compounds, together with earthed metal transformer casings and other large earthed metallic structures will perturb the electric field. As transformer compounds typically occupy a relatively small area, the consequence of the field perturbation will be to reduce the electric field strength close to ground level. Hence, in general the electric field strengths measured inside transformer compounds were below both the low action levels and the Council Recommendation reference levels, although at Staythorpe electric field strengths in the generator transformer compound under relatively low-slung conductors were 110 % of the reference levels. Electric field strengths outside transformer and banking compounds and beneath outgoing conductors were all below both the low action levels and the reference levels. In these cases conductors are often higher than in the transformer compounds and earthed metal fencing to a height of approximately 2 m will normally still be present.

Magnetic fields

In general the isolated phase bus is inaccessible, but access is sometimes provided for the purposes of inspection or access to the main generator circuit breaker. Electric currents induced in the outer metal casing of the isolated phase bus will tend to generate magnetic fields that cancel those produced by current flow through the conductors. As a result fields close to the bus do not exceed the low action levels, although they may well exceed the Council Recommendation reference levels with the maximum measured value being 400 % for a standard bus. Where inspection windows are present, field strengths may be even higher with a maximum measured value being 570 % of the reference levels.

Magnetic flux densities around generator and unit auxiliary transformers did not exceed the low action levels for any of the surveys. However, strong fields representing up to 700 % of the reference levels were measured around generator transformers, although there was considerable variation from site to site, presumably reflecting the details of individual

installations and accessibility of phase tanks. Magnetic fields around unit auxiliary transformers were generally lower, although where output cables were accessible, the fields around these could be up to 700 % of the reference levels. Interestingly strong fields were also measured in the vicinity of the earth conductors connected to the transformers (and at Aberthaw an earth conductor from a high voltage switch room), which could also represent up to 700 % of the reference levels.

Strong magnetic fields have been measured in 11 kV switch rooms. At Drax magnetic flux densities exceeded the low action levels, but only over a very localised region that could not give rise to a whole body exposure. Accessible fields around switch gear were around 100 % of the reference levels in a number of cases. Field strengths in 6.6 kV and 415 V switch rooms were generally much lower and did not exceed the action or reference levels, so fields in these areas are not hazardous.

Accessible magnetic flux densities around the boundaries of banking compounds, National Grid substations and outgoing conductors were generally well below the action and reference levels and are not hazardous. At Aberthaw, where the National Grid substation is fed from underground cables, field strengths at the ground surface were at the reference levels, but this is not considered to be a normally accessible location.

3.32.4 Control measures

In the absence of a person-specific individual assessment, workers at particular risk should be excluded from access to the generator and unit auxiliary transformer compounds, and high voltage switch rooms during operation of the unit. As these are normally areas with restricted access, this should be straightforward.

Access to earth conductors may also need to be considered where these carry high currents outside restricted areas.

3.32.5 Triggers for reassessment

Unusual configuration resulting in abnormally large separation of phases, where they would normally be bundled together could lead to higher resultant fields.

3.32.6 Assessment performed by

Public Health England under contract to Energy UK. Inserted in this risk assessment by John Swanson 29/6/16.

3.33 Ancillary Equipment

3.33.1 Description of activity

A wide range of motors are used to drive cooling water pumps, oil pumps, feed water pumps, cooling tower drives and booster fans. In addition, coal- and biomass-fired power stations normally have motors driving conveyors and vibratory feeders as part of their fuelling systems. They may also have equipment such as precipitators to removed fine particles from flue gasses, along with flue gas desulphurisation (FGD) systems.

3.33.2 Summary of exposures

Electric fields

There are no exposed high voltage conductors associated with any of the ancillary equipment and consequently no expectation of strong electric fields.

Magnetic fields

None of the ancillary equipment is expected to generate magnetic flux densities that exceed the low action levels. Some pump and fan motors generate magnetic fields that are strong enough to exceed the Council Recommendation reference levels in close proximity to the motor housings. In general magnetic flux densities fall rapidly with distance so that exposures would be below the reference levels within 0.3 m. These highly localised strong fields should not present a risk to most workers at particular risk. However, workers with active implanted medical devices required to work in close proximity to an operating motor could be at risk.

The size or power of a motor is not a good predictor for the strength of the field generated. This is illustrated by the cooling water pump shown in Figure 2. The magnetic flux density at the surface of the main pump represented <1 % of the low action levels and 1.3 % of the reference levels. In contrast the field at the surface of the small motor for the auxiliary cooling water pump, which provides cooling water to cool the main pump, represented 590 % of the reference levels.

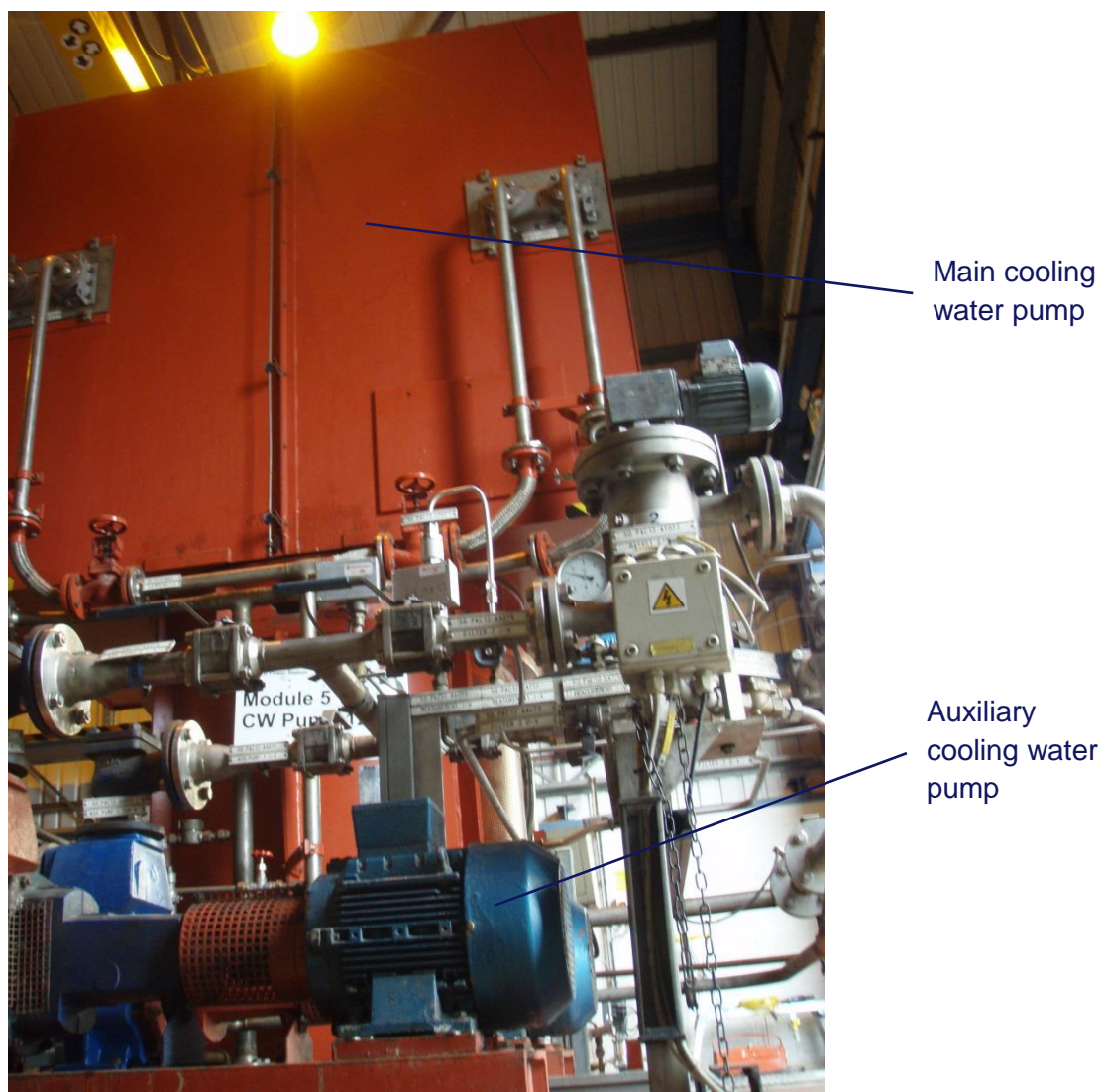

Figure 2 Main and auxiliary cooling water pumps at Didcot B Power Station

3.33.3 Assessment of exposures

Electric fields

There are no unscreened high voltage conductors in these areas and consequently no source for strong electric fields. There is no requirement to make any further assessment of exposures in these situations.

Magnetic fields

Accessible magnetic fields measured around high power motors such as those driving cooling water pumps were variable, with the lowest representing just 1.3 % and the highest 370 % of the Council Recommendation reference levels. This range probably reflects a number of factors including the age of the motors (modern motors will often be more efficient) the thickness of the pump housing and the presence or absence of acoustic insulation. In general field strengths fell rapidly with distance and the fields would be unlikely to result in whole body exposures. Large fan motors were also variable, with some generating strong fields in close proximity to the motor, but again these would be unlikely to

result in whole body exposures in excess of either the low action levels or the reference levels.

Accessible magnetic flux densities were often higher for smaller lower power motors, such as those driving feed water pumps, oil pumps, and ventilation fans, where exposures could exceed the reference levels close to the motors. Perhaps the best example of the difference between large and small motors was the cooling water pump at Didcot B. Here the magnetic flux density at the surface of the motor for the main cooling water pump was only 1.3 % of the reference levels, but the field generated by the motor of the auxiliary pump delivering coolant to the main pump was 590 % of the reference levels. In general, fields from small motors fall rapidly with distance, so that they should not result in hazardous exposures for workers at particular risk who are working in the general area. However, there may be risks for workers with active implanted medical devices if they are required to work very close to one of these small motors whilst it is operating.

Similarly motors associated with conveyors and vibratory feeders were also variable, but in this case generally below the action and reference levels.

Strong fields were also generated around precipitator supply and control equipment, particularly the rectifiers. However, the strongest field represented just 2.9 % of the low action levels and 74 % of the reference levels and is not hazardous.

3.33.4 Control measures

There is no need for general restriction on access to areas housing ancillary equipment. In the absence of a person-specific individual assessment, workers with active implanted medical devices should not be required to work in close proximity to operational motors.

3.33.5 Triggers for reassessment

More efficient motor designs may result in reduced field generation.

3.33.6 Assessment performed by

Public Health England under contract to Energy UK. Inserted in this risk assessment by John Swanson 29/6/16.